

DIGITAL METERS

Large Display Process Meter With
Rate/Totalizer/Batch Control Features
Model PD655 Instruction Manual



- Easy Single Button Scaling (SBS)
- 4-20 mA, 1-5 V, 0-5 V, or 0-10 V Field Selectable Inputs
- Large 1.0" (25.4 mm) High LEDs
- Full Six Digit Display for Total, 4½ Digit + Extra Zero for Process/Rate
- Total Displayed in any Engineering Unit
- Display in Engineering Units; Rate per Second, Minute, Hour, or Day
- Scale Without a Calibrator
- 11-Point Calibration for Non-Linear Inputs
- Automatic Square Root and Programmable Exponent
- Low-Flow Cutoff
- NEMA 4X Impact-Resistant Glass Filled Polycarbonate Enclosure
- Two 24 VDC Isolated Power Supplies
- 115 or 230 VAC Power, Field Selectable; 24 VDC Optional
- Quick Preset Change Feature for Batch Control
- Pump Alternation Control Feature
- 2 or 4 Relays + 4-20 mA Output Options

PRECISION DIGITAL CORPORATION
19 Strathmore Road • Natick MA 01760 USA
Tel (800) 343-1001 • Fax (508) 655-8990



www.predig.com

Visit our Website
<http://www.predig.com>

Table of Contents

INTRODUCTION ----- 7

Key Features ----- 7

Typical Applications ----- 8

Ordering Information ----- 8

Safety Notice ----- 9

Specifications ----- 10

 Basic Process Meter ----- 10

 Rate/Totalizer/Batch Controller Features ----- 11

 Options ----- 12

Display Functions and Messages ----- 15

SETUP AND PROGRAMMING ----- 17

Overview ----- 17

Disassembling the Meter ----- 18

Reassembling the Meter ----- 18

Jumper Configuration ----- 19

 Overview ----- 19

 Jumper Arrays Function and Location ----- 19

Power Selection ----- 20

 Overview ----- 20

 Changing from 115 to 230 VAC Power ----- 20

 Labeling Meter for 115 VAC, 230 VAC, or 24 VDC ----- 20

Connections ----- 21

 Overview ----- 21

 Wiring Instructions ----- 22

 Terminals Designation ----- 22

 Power Connections ----- 23

 Signal Connections ----- 24

 Enter, Acknowledgement, and Reset Total Connections ----- 26

 Optional Relays & 4-20 mA Output Terminals ----- 26

 Isolated 4-20 mA Output Option Connections ----- 27

Programming ----- 28

 Overview ----- 28

 General Programming Description ----- 28

 ENTER and ACK Functionality ----- 28

 Five Basic Digit/Display Setting Instructions ----- 30

 Basic Meter Programming ----- 32

 Overview ----- 32

 Select Input Signal ----- 32

 Select Calibration Method ----- 33

 Initial Calibration With External Source (if Needed) ----- 33

 Scale or Calibrate the Meter ----- 34

 Scale Using Internal Calibration ($I-IRL$) ----- 34

 Minimum Input Span (*Error* Message) ----- 35

 Calibrate Using External Calibration ($E-IRL$) ----- 38

 Calibrate Using External Calibration ($E-IRL$) ----- 38

 Round Horizontal Tank Calibration Points ----- 40

 Calibration Error (*Error*) ----- 40

 Rate Meter Programming ----- 41

Overview	41
Set Display to Rate (<i>d5PY r</i>)	41
Low-flow Cutoff Programming (<i>LFtOFF</i>)	42
Totalizer Programming	43
Overview	43
Set Display for Total (<i>d5PY t</i>)	43
Set Rate Time Base (<i>t bR5E</i>)	44
Set Totalizer Conversion Factor (<i>tot CF</i>)	44
Set Totalizer Decimal Point (<i>tot dP</i>)	45
Set Alternating Total/Rate Display	46
Parameter Combinations Resulting in Error Message (<i>Error t</i>)	46
Set Point Setup and Programming	47
Overview	47
Set Relays for Manual or Automatic Reset	48
Set Relays for Fail-Safe Operation	48
Assigning Set Points to Process/Rate or Total (<i>SEtUP</i>)	49
Rate or Total, Latching or Non-Latching Relays	50
Programming Internal Total Reset and Delay (<i>dELRY</i>)	52
Setting Relays for Pump Alternation (<i>RLtErn</i>)	53
Programming Alarm Points and Presets (<i>SEtPt5</i>)	54
Overview	54
Set and Reset Points for Process/Rate Alarms	54
Preset Values for Total Set Points	54
Preset Offset Values for Total Set Points (<i>OFF5Et</i>)	54
Programming Alarm and Preset Values (<i>SEtPt5</i>)	55
4-20 mA Isolated Output Option Programming (<i>outPut</i>)	59
4-20 mA Output Programming Confirmation	59
Lockout and Display Selection Programming	60
Overview	60
Lockout	60
Display Selection (<i>d5PLRY</i>)	61
Alternating Display	62
Include or Exclude Menu Titles From Menu Scroll	63
OPERATION	64
Overview	64
Two Types of Display: Process/Rate and Total	65
Basic Meter Operation	66
Overview	66
ENTER and ACK Button Operation	66
Display Peak & Reset Peak Operation (<i>d5PY P & r5Et P</i>)	67
Rate Meter Operation	68
Overview	68
Display Rate (<i>d5PY r</i>)	68
Low-Flow Cutoff (<i>LFtOFF</i>)	68
Totalizer Operation	69
Overview	69
Display Total (<i>d5PY t</i>)	69
Total Conversion Factor (<i>tot CF</i>) & Time Base (<i>t bR5E</i>)	69
Applications Using Total Conversion Factor and Time Base	70
Totalizer Reset	71
Resetting Total Using the ENTER Button	71
Resetting Total via External Contact Closure	71

Resetting Total Automatically via User Selectable Preset	71
Relays Operation	72
Overview	72
Relays Auto Initialization	72
Fail-Safe Operation	72
Front Panel LEDs	73
Acknowledging Relays	75
Simple On/Off Control with 100% Deadband Operation	76
Manual Batch Control Operation	78
Automatic Batch Control Operation	79
Delay on Release (<i>dEL R4</i>)	80
Priority Batch Programming or Quick Presets	80
Batch Control with Varying Batch Sizes	80
Pump Alternation Control	81
Pump Alternation Typical Application	81
Switching Inductive Loads	82
AC and DC Loads	82
Low Voltage DC Loads	82
4-20 mA Output Operation	83
Overview	83
Lockout and Display Selection Operation	83
Overview	83
Low Voltage Detector	83
INSTALLATION	84
Wall Mounting Dimensions	85
Panel Mounting Instructions	86
OPTION CARD REMOVAL & INSTALLATION	87
PROGRAMMED PARAMETER SETTINGS	89
Diagnostic Feature (<i>d I89</i>)	93
Overview	93
Operation	93
OTHER PRECISION DIGITAL PRODUCTS	94

List of Figures

Figure 1.	Removing the Display Board.....	18
Figure 2.	Input Power Label	20
Figure 3.	Connections and Jumper Diagram	21
Figure 4.	Options Board Connectors and J5 Jumper	22
Figure 5.	Input Power Connections	23
Figure 6.	Two-Wire Transmitter Powered by Meter	24
Figure 7.	Two-Wire Transmitter Powered by External Supply.....	24
Figure 8.	Three-Wire Transducer Powered by Meter.....	25
Figure 9.	Direct Voltage Signal Connections.....	25
Figure 10.	Optional Unregulated Supply Connections	25
Figure 11.	External Control Connections.....	26
Figure 12.	Relay and 4-20 mA Output Terminals.....	26
Figure 13.	Both Input and Output Loops Powered by Meter	27
Figure 14.	Input Loop Powered by Meter, Output Loop Powered from External Supply	27
Figure 15.	Jumper Arrays and Status LED Identification	29
Figure 16.	Two-Point Calibration Flowchart	31
Figure 17.	JP1 Input Signal Selection Array.	32
Figure 18.	Display Showing Location of Set Point LEDs.....	55
Figure 19.	Display Showing Location of Set, Reset, and Rate LEDs	55
Figure 20.	Programming Status of Set Point LEDs Assigned to Total	56
Figure 21.	Functions Locked Out with the Lockout Jumper	60
Figure 22.	Menu Titles Excluded with Display Menu.....	61
Figure 23.	Front Panel LEDs	64
Figure 24.	Meter Displaying Process/Rate	65
Figure 25.	Meter Displaying Total	65
Figure 26.	Front Panel LED Indicator Locations.....	73
Figure 27.	AC and DC Loads Protection	82
Figure 28.	Low Voltage DC Loads Protection.....	82
Figure 29.	Overall Dimensions.....	84
Figure 30.	Wall Mounting Dimensions.....	85
Figure 31.	Wall Mounting Screw	85
Figure 32.	Panel Mounting Instructions	86
Figure 33.	Removing the Display Board.....	87
Figure 34.	Options Board Standoffs Location	87
Figure 35.	Installing Option Board.....	88

INTRODUCTION

This instrument is an analog input process meter with flow rate, totalizer, and batch control capabilities housed in a rugged, impact-resistant glass filled polycarbonate, NEMA 4X enclosure. It accepts the common process signals such as 4-20 mA, 0-5 VDC, 1-5 VDC, and 0-10 VDC. It displays these signals in engineering units on a 1.0" high 4½ digit LED display. The meter also provides two isolated 24 VDC power supplies to drive both the input and output loops. Options include up to 4 relays for alarms or batch controlling as well as an isolated 4-20 mA transmitter output.

Key Features

This model contains several features of interest:

- Two 24 VDC Isolated Transmitter Power Supplies*
- 115 or 230 VAC Field Selectable Power
- Rate Display in Units per Day, in Addition to Second, Minute, and Hour
- Programmable Set points for Latching and Non-Latching Relay Operation
- Built-in Snubbers on Each Relay Contact
- Any Set Point Programmable for Process/Rate or Total
- Quit or Exit Menu Scroll with ACK Button
- Pump Alternation Control Feature for Rate Relays
- Automatic Square Root Extraction for Differential Pressure Transmitters
- Programmable Exponent for Weirs and Flumes

*Optional 18 VDC (nominal) @ 200 mA (maximum) unregulated power supply can be provided instead of the two 24 VDC supplies. See Ordering Information, page 8 for details.

Typical Applications

Level:

Sump Pump Control
 Water Tank Level
 Round Horizontal Tank Volume Measurement
 Well Draw-down
 Lift Station Control

Flow:

Square Root Extraction from Differential Pressure Transmitter
 Programmable Exponent for Weirs and Flumes
 Rate, Total, and Batch Control

Pressure:

Compound Pressure
 High Pressure Alarms

Temperature:

Heat Exchanger Display and Alarm
 Boiler Temperature Monitoring
 Gas Turbine Combustor Alarm
 Condenser Temperature Indicator

Ordering Information

115/230 VAC Model ¹	24 VDC Model	Options Installed	Option Cards ²
PD655-N	PD655-2-N	No Options	
PD655-44	PD655-2-44	2 Relays	PD474
PD655-45	PD655-2-45	4-20 mA Output	PD475
PD655-46	PD655-2-46	2 Relays + 4-20 mA Output	PD476
PD655-47	PD655-2-47	4 Relays	PD477
PD655-48	PD655-2-48	4 Relays + 4-20 mA Output	PD478

Accessories

PDA6554 Panel Mounting Kit³
 PDA6545 2" Pipe Mounting Kit

¹ Optional 18 VDC (nominal) @ 200 mA (maximum) unregulated power supply can be provided instead of the two 24 VDC supplies. Request modification MOD0010.

² Option Cards (when ordered separately)

³ The PDA6554 panel mounting kit is not intended to provide waterproof protection to the panel.

Safety Notice



CAUTION: Read complete instructions prior to installation and operation of the unit.



WARNING: Risk of electric shock.



Observe all safety regulations. Electrical wiring should be performed in accordance with all applicable national, state, and local codes to prevent damage to the unit and ensure personnel safety.

Do not use this unit to directly drive heavy equipment such as pumps, motors, valves, etc.



It is recommended to use this meter in a fail-safe system that accommodates the possibility of meter failure or power failure.



WARNING

Hazardous voltages exist within enclosure. Only trained service personnel should perform installation and service.



AVERTISSEMENT

Les pièces à l'intérieur du boîtier portent des tensions dangereuses. Seules des personnes qualifiées et bien entraînées devraient entreprendre l'ótalonnage et la maintenance.

Disclaimer

The information contained in this document is subject to change without notice. Precision Digital makes no representations or warranties with respect to the contents hereof, and specifically disclaims any implied warranties of merchantability or fitness for a particular purpose.

Specifications

Except where noted all specifications apply to operation at +25°C.

Basic Process Meter

INPUTS	Field selectable: 4-20 mA, 0-20 mA, 0-5 V, 1-5 V, 0-10 V	
DISPLAY	Six digit, 1.0" (25.4 mm) high efficiency red LED. Rate: -19999(0) to 29,999(0) with selectable extra zero Total: 0 to 999,999; automatic lead zero blanking	
DECIMAL POINT	Process/rate display: 2.9999, 29.999, 299.99, 2999.9, or 299990. Total decimal point: 9.99999, 99.9999, 999.999, 9999.99, or 99999.9. Rate and total decimal points are independent of each other.	
CALIBRATION RANGE	4 mA (1 V) input may be set anywhere in range of the meter. 20 mA (5 V) may be set anywhere in range of the meter above or below 4 mA input. An <i>Error</i> message will appear if input 1 signal and input 2 signals are too close together.	
	Input Range	Minimum Difference Between Input 1 & Input 2
	0-5 V	0.16 V
	0-10 V	0.32 V
	4-20 mA	1.60 mA
INPUT IMPEDANCE	Voltage ranges: greater than 300 K Ω Current ranges: 100 Ω	
LOOP POWER SUPPLY	Two isolated power supplies, 24 VDC \pm 5% @ 20 mA each, regulated. Maximum loop resistance is 1200 Ω .	
OPTIONAL POWER SUPPLY	18 VDC (nominal) @ 200 mA (maximum) unregulated power supply can be provided instead of the two 24 VDC supplies.	
ACCURACY	Linear input: \pm 0.05% of calibrated span \pm 1 count Root extraction: \pm 0.1% F.S. \pm 2 counts	
ROOT EXTRACTION	Square root extraction: Automatic Programmable exponent: Greater than 1 and smaller than 3	
11 POINT LINEARIZATION	Input Range	Minimum Span Between Inputs
	4-20 mA	(1.6 mA \div (Number of points -1))
	0-5 V	(0.16 V \div (Number of points -1))
	0-10 V	(0.32 V \div (Number of points -1))
	e.g. Minimum span for an 11-point, 4-20 mA calibration is 0.16 mA between inputs.	
TIME BASE	Second, minute, hour, or day	
ALARM POINTS	Four, any combination of high or low alarms	
ALARM POINT DEADBAND	0-100% of full scale, user selectable	
ALARM STATUS INDICATION	Front panel LED	

PEAK HOLD MAX (DISPLAY PEAK)	Captures the maximum or peak process/rate and displays it via the front panel ENTER button (dSPY P)
PEAK HOLD OR MAX INDICATION	Front panel flashing "R" LED
LOCKOUT	Jumper JP1 labeled "LOCK" restricts modification of programmed settings.
NON-VOLATILE MEMORY	All programming values are stored in non-volatile memory for a minimum of ten years if power is lost.
POWER OPTIONS	AC power: 115 or 230 VAC (field select) $\pm 10\%$, 50/60 Hz, 12 VA DC power: 22-28 VDC; 12 watts maximum
NORMAL MODE REJECTION	64 dB at 50/60 Hz
ENCLOSURE	Impact-resistant glass filled polycarbonate, NEMA 4X, IP 67 (IEC 529), color: gray (RAL 7035); two holes for 1/2" conduit provided at base.
ENVIRONMENTAL	Operating temperature range: -20 to 65°C Storage temperature range: -40 to 85°C Relative humidity: 0 to 90% non-condensing
CONNECTIONS	Removable screw terminal blocks, accept 22 to 12 AWG wire
MOUNTING	The enclosure contains four holes for wall mounting. Panel mounting kit is available.
OVERALL DIMENSIONS	6.7" x 5.5" x 3.7" (170 mm x 140 mm x 95 mm)
WEIGHT	3.8 lbs (1.73 kg)
WARRANTY	2 years parts & labor
EXTENDED WARRANTY	1 or 2 years, refer to the Price List for details.

Rate/Totalizer/Batch Controller Features

RATE DISPLAY INDICATION	LED labeled "R" in lower right illuminates when meter is displaying rate or process input.
LOW-FLOW CUTOFF	Any input below the low-flow cutoff value will result in a display of zero. May be set from 1 count to 100% F.S., user selectable. To disable low-flow cutoff, program cutoff value to zero. Totalizer is based on rate display. So, inputs below the low-flow cutoff value will not affect the totalizer.
ALTERNATING DISPLAY	Display may be programmed to alternate between rate and total every 10 seconds.
TOTAL DISPLAY	0 to 999,999, automatic lead zero blanking
TOTAL DECIMAL POINT	May be set in any of the following positions: 9.99999, 99.9999, 999.999, 9999.99, or 99999.9. Total decimal point is independent of process/rate decimal point.

TOTAL CONVERSION FACTOR	Programmable from 0.00001 to 59999
TOTALIZER	Calculates total based on rate and field programmable total conversion factor to display total in engineering units. Time base must be selected according to time units in which rate is displayed.
TOTALIZER ROLLOVER	Totalizer "rolls over" when display exceeds 999,999. Relay status reflects display.
TOTALIZER PRESETS	Up to four, user selectable under setup menu SEtUP . Any set point can be assigned to total and may be programmed anywhere in the range of the meter.
PRESET OFFSET	Relays assigned to total can be programmed to trip at any point below the next relay's preset value.
PROGRAMMABLE DELAY ON RELEASE	If the meter is programmed to reset total to zero automatically when the highest preset is reached, then a delay will occur before the total relays reset. This delay can be programmed anywhere from 1 to 999 seconds.
PRIORITY BATCH PROGRAMMING	This feature allows the user to quickly change preset values without going into the main menu by holding the ENTER button for more than 3 seconds.
TOTAL RESET	Via front panel ENTER button, external contact closure, or automatically via user selectable preset value.
TOTAL RESET LOCKOUT	Meter may be programmed so total cannot be reset from front panel.

Options

Relays	
RATING	2 or 4 SPDT (Form C); rated 2 A @ 30 VDC or 2 A @ 250 VAC resistive load; $\frac{1}{14}$ HP @ 125/250 VAC for inductive loads. Built-in suppression.
ASSIGN TO PROCESS/RATE OR TOTAL	Any relay may be assigned to process/rate or total.
BUILT-IN SUPPRESSION	A built-in suppressor (snubber) to prolong the life of the relays protects each relay contact. The suppressor provides a degree of protection against electrical noise caused by inductive loads. Suppressor value: .01 μ F/470 Ω , 250 VAC.
DEADBAND	0-100% of full scale, user selectable
HIGH OR LOW ALARM	User may program any alarm for a high or low trip point.
RELAY OPERATION	Latching or non-latching

FAIL-SAFE OPERATION	Relay coils are energized in non-alarm condition. In case of power failure, relays will go to alarm state. Fail-safe operation may be disabled, by removing jumper J5 located on the Options Board.
AUTO INITIALIZATION	When power is applied, relays assigned to total will reflect the state of the accumulated total value in memory. Relays assigned to process/rate will reflect the state of the input to the meter.
RELAYS RESET	
Total relays reset	<ol style="list-style-type: none"> 1. When total is reset to zero, if set up for external total reset 2. After delay has elapsed, if set up for internal total reset 3. Manual any time, if set up for external total reset (via user supplied external contact closure at terminals AK and CM or front panel ACK button) <p>Note: Manual reset resets all manually resettable relays.</p>
Process/rate relays reset	<ol style="list-style-type: none"> 1. Automatic reset only 2. Manual reset only, at any time 3. Automatic plus manual reset at any time 4. Manual reset only after alarm condition has been corrected <p>Automatic reset: Relays will automatically reset when the input passes the reset point.</p> <p>Manual reset: It can be performed via user supplied external contact closure at terminals AK and CM or front panel ACK button. Manual reset resets all manually resettable relays.</p>

Isolated 4-20 mA Transmitter Output			
CALIBRATION RANGE	The transmitter output can be calibrated so that a 4 mA output is produced for any process/rate measured by the meter. The 20 mA output may correspond to any process/rate that is at least 501 counts greater or smaller than the process/rate corresponding to 4 mA. (Ex. 4 mA = 0, 20 mA = 501) If the span between 4 and 20 mA is less than 501 counts, an Error message will appear.		
EQUIPMENT NEEDED	The 4-20 mA output from the meter is calibrated without the use of a calibrator.		
OUTPUT LOOP POWER SUPPLY	24 VDC \pm 5% @ 20 mA, regulated. Maximum loop resistance is 1200 Ω . Isolated from input transmitter power.		
ACCURACY	\pm 0.1% F.S., \pm 0.004 mA		
ISOLATION	500 VDC or peak AC, input-to-output or input/output-to-power line		
EXTERNAL LOOP-POWER SUPPLY	35 VDC maximum		
OUTPUT LOOP RESISTANCE	Power supply	Minimum loop resistance	Maximum loop resistance
	24 VDC	10 Ω	600 Ω
	35 VDC (external)	600 Ω	1000 Ω

Display Functions and Messages

The meter displays various functions and messages during operation and programming. The following table shows the various displayed functions and messages with their description.

Display	Parameter	Description/Comments
18888L	Low voltage	Indicates an input voltage below specifications during power up.
- 19999	Underrange	Indicates the input signal is below the negative range of the meter.
2 Pt5	2 points	Indicates number of calibration points selected (2 to 11 points can be selected).
29999	Overrange	Indicates the input signal exceeds the full-scale range of the meter.
ALtErn	Alternate	Sets any relay pair for pump alternation control.
CAL Ib	External calibration	Calibrates unit using a calibrated signal source.
CuToFF	Low-flow cutoff	Sets meter to display zero below programmed cutoff point.
dAY	Day	Sets time base to display rate in units per day.
dELAY	Delay	Sets delay on release from 1 to 999 seconds for internal total reset.
d IAG	Diagnostic	Displays parameter settings one at a time for diagnostic purposes. Setting can not be changed under this function.
dSPRAY	Display	Sets menu title scroll, selections are activated with lockout jumper installed.
dSPY 1	Display 1	Sets display 1 calibration.
dSPY 2	Display 2	Sets display 2 calibration.
dSPY P	Display peak	Displays the highest process/rate value captured.
dSPY r	Display process/rate	Sets process/rate as default display.
dSPY t	Display total	Sets total as default display.
E rSt	External total reset	Indicates total reset was set to externally reset total to zero via the ENTER button or an external switch closure.
E-CAL	External calibration	Sets meter to calibrate using a calibrated signal source.
Error	Error	Indicates calibration was not successful.
Error 1	Error 1	Indicates a combination of parameters that exceeds the totalizer capabilities.
Hour	Hour	Sets time base to display rate in units per hour.
I or E	Internal or external	Sets highest preset for internal or external total reset.
I rSt	Internal total reset	Indicates highest preset was set to internally reset total to zero when preset value is reached.
I-CAL	Internal calibration	Sets meter for internal calibration to scale meter without applying an input signal.
INPt 1	Input 1	Sets input 1 calibration point.
INPt 2	Input 2	Sets input 2 calibration point.
LALtCH	Latch	Sets process/rate set points for Latching or Non-latching relay operation.

Display	Parameter	Description/Comments
L InEAR	Linear input	Indicates linear input was selected.
n r n	Minute	Sets time base to display rate in units per minute.
no PLS	Number of points	Sets meter for 2 to 11 calibration points.
OFFSEt	Preset offset	Sets preset offset value (Relay n trips at a point below Relay n+1 preset value).
outPut	Output	Sets the optional 4-20 mA output values.
Progr	Programmable root	Sets exponent for special root extraction used for weirs and flumes.
r or t	Rate or total	Sets set points for process/rate or total.
rRtE	Rate	Indicates set point was assigned to rate.
rSEt P	Reset peak	Erases peak value from memory and captures a new peak reading.
rSEt t	Reset total	Resets the totalizer to zero.
SCALE	Scale	Scales meter using internal calibration for desired display (Signal source not required).
SEC	Second	Sets time base to display rate in units per second.
SEt 1	Set point 1	Sets operation for set point 1.
SEt 2	Set point 2	Sets operation for set point 2.
SEt 3	Set point 3	Sets operation for set point 3.
SEt 4	Set point 4	Sets operation for set point 4.
SEtPLS	Set points	Sets alarm set /reset points and total presets (relays are optional).
SEtUP	Setup	Sets operation of set points for process/rate or total, latching or non-latching, etc.
SqURrE	Square root	Sets meter for square root extraction.
t bASE	Time base	Sets meter with correct time unit factor (second, minute, hour, or day).
tot CF	Totalizer conversion factor	Sets multiplier factor to display total in any engineering unit.
tot dP	Total decimal point	Sets the decimal position for the totalizer.
totAL	Total	Indicates set point was assigned to total.
Y or n	Yes or no	Sets selection or de-selection of various functions.

SETUP AND PROGRAMMING

Overview

To set up and program the meter, it is necessary to disassemble the Display Board. See disassembling instructions in the next pages.

Setting up and programming the meter involves four basic steps:

1. Jumper Configuration (Page 19)
 - a. Input selection and lockout jumpers
 - b. Relay acknowledge enable
 - c. Fail-safe operation of relays
2. Power Selection (Page 20)
 - a. Changing to 230 VAC power if needed. Factory default is 115 VAC.
 - b. Labeling meter for input power: 115 VAC, 230 VAC, or 24 VDC
3. Connections (Page 21)
 - a. Power
 - b. Input signal
 - c. Enter, acknowledgement, and reset total
 - d. Relays
 - e. 4-20 mA output
4. Programming (Page 28)
 - a. Basic meter
 - b. Process/rate meter
 - c. Totalizer
 - d. Batch controller
 - e. Relays
 - f. 4-20 mA output
 - g. Lockout and display selection

Programmed Parameter Settings

To simplify programming, write down the desired programming values prior to attempting to program the meter. The ***Programmed Parameter Settings*** form located at the back of this manual provides a convenient method to record the user settings; it also provides the factory setting for most of the programmable parameters.

Jumper Configuration

Overview

Before programming the meter, it is necessary to configure three jumper arrays. The jumper arrays are used for setting type of input signal (4-20 mA, 0-5 V, or 0-10 V); locking out the programmed settings, enable relay acknowledgement (ACK), and setting relay fail-safe operation.

Jumper Arrays Function and Location

Jumper Array Function	Label	Location	Diagram
Input signal and Lockout	JP1	Main Board	Figure 3
Relay ACK enable	JP5	Display Board	Figure 15
Fail-safe	J5	Options Board	Figure 4

Input Selection and Lockout Jumpers

Jumper JP1 Position	Function
No jumper	Sets input to 5 V
20 mA	Sets input to 20 mA
10V	Sets input to 10 V
LOCK	Sets a lock on programming functions

Relay Acknowledge Enable

Jumper JP5 Position	Function
1	Enable relay 1 manual reset
2	Enable relay 2 manual reset
3	Enable relay 3 manual reset
4	Enable relay 4 manual reset

Fail-Safe Operation of Relays

Jumper J5 Position	Function
On	Apply fail-safe function to all relays
Off	Disable fail-safe function to all relays

Power Selection

Overview

Power Selection involves the following:

1. Changing to 230 VAC power if needed. Factory default is 115 VAC.
2. Labeling the meter as to how it will be powered: 115 VAC, 230 VAC, or 24 VDC. Meters powered from 24 VDC are labeled as such at the factory.

Note: Meters ordered to operate from 24 VDC do not require any special setup, this option is not field selectable.



All AC powered meters are shipped from the factory set for 115 VAC power. Do not apply 230 VAC without first setting up the meter to accept this voltage.



Disconnect power prior to performing the following procedures. The meter is field selectable for either 115 VAC or 230 VAC power. Changing the voltage selection involves the removal of the front cover and the Display Board, then selecting 115V or 230V on switch S1 located on the Main Board.



Observe polarity for DC powered meters. Applying voltage with reverse polarity may damage the meter.



Do not apply an AC voltage to DC powered meters. Applying an AC voltage to DC powered meters will result in damage to the meter and endanger personnel.

Changing from 115 to 230 VAC Power

To access the 115/230 VAC switch it is necessary to remove the housing cover and the Display Board, see *Disassembling the Meter*, page 18.

Once the Display Board has been removed, switch S1 is visible. It is the large black component with a red slide switch on the top, located next to the transformer. For location see Figure 3, page 21.

For 115 VAC operation, the switch shows 115V; for 230 VAC it shows 230V.

Several setup steps are required and connections made while Display Board is removed, so it should not be reinstalled just yet. However, to avoid electric shock, install Display Board prior to applying power.

Labeling Meter for 115 VAC, 230 VAC, or 24 VDC

<p>CAUTION</p> <p>ALL AC POWERED UNITS ARE SHIPPED FROM THE FACTORY SET FOR 115 VAC</p> <p>(SEE INSTRUCTION MANUAL TO CHANGE VOLTAGE SELECTION)</p>	<input type="checkbox"/> 115 VAC
	<input type="checkbox"/> 230 VAC
	<input type="checkbox"/> 24 VDC



A label on top of the unit contains a place for the user to indicate if the unit is powered from 115 or 230 VAC. The user should mark the appropriate box once the desired power has been selected on switch S1.

Figure 2. Input Power Label

Connections

Overview

The following connections are made to removable screw terminal connectors supplied with each meter:

Power Connections

Signal Connections

Enter, Acknowledgement, and Reset Total Connections

Relays Connections

4-20 mA Output Connections

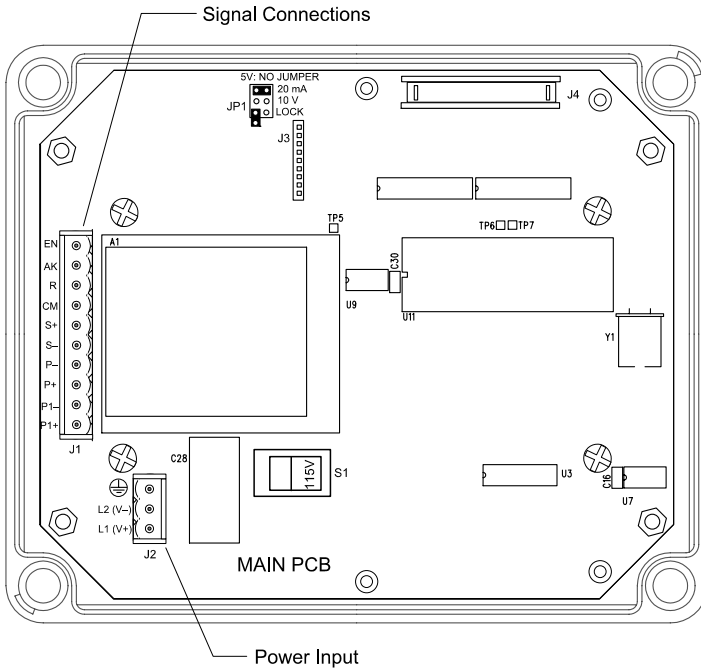

Figure 3. Connections and Jumper Diagram

Connector	Location	Function	Wire Size
J1	Main Board	Signal connections	12-22
J2	Main Board	Power connections	12-18
J3	Main Board	Connections to Options Board	
J4	Main Board	Connections to Display Board	
J1	Options Board	4-20 mA output	12-22
J2	Options Board	Connections to Main Board	
J3	Options Board	Relays 1 & 2 Connections	12-18
J4	Options Board	Relays 3 & 4 Connections	12-18

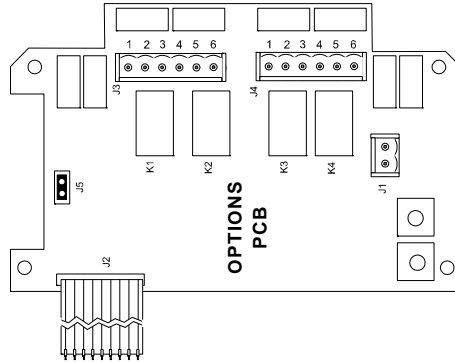



Figure 4. Options Board Connectors and J5 Jumper

Wiring Instructions

Refer to Figure 3 and Figure 4 for connectors' location.

1. All field connections to be made with insulated copper wire, either solid or stranded. Tighten all screw terminals to 4.5 lb-in (0.5 Nm). Strip length = ¼ in (7 mm). **DO NOT** pre-treat wire with solder.
2. **Terminals Earth Ground, L2(V-), L1(V+) on J2 (Main Board) and terminals 1-6 on J3-J4 (Options Board):** Use AWG #12-18 wire, 600 volt, 60°C. Connect only one wire to each terminal.
3. **Terminals EN, AK, R, CM, S+, S-, P-, P+, P1-, P1+ on J1 (Main Board) and terminals +, - (Options Board):** Use AWG #12-22 wire, 150 volt, 60°C. If using AWG #20 or smaller wire, up to two wires may be connected to each terminal. If using AWG #18 or larger wire, only one wire may be connected to each terminal.
4. Install conduit hubs to the enclosure cable input ports. To maintain NEMA 4X rating use only UL/CSA watertight conduit hubs.
5. Feed all wires through the enclosure cable input ports.
6. Remove one connector at a time from the headers and connect the wires to the connector.
7. After wiring a connector, insert it back into the header.

Terminals Designation

Terminal	Description
L1, L2	AC input power
V+, V-	DC input power
	Earth ground
P+, P-	24 VDC transmitter power supply
P1+, P1-	24 VDC output power supply
S+, S-	Input signal

Terminal	Description
CM	Common (return) for R, AK, EN
R	External total reset
AK	External relay acknowledge
EN	External enter
+, -	4-20 mA output
1-6	Relay 1-4

Power Connections



Refer to **Changing from 115 to 230 VAC Power**, page 20, to make sure meter is set up to accept proper voltage before applying power.



Disconnect power to the meter before making any connections.



Do not connect Power or Earth Ground to any unused or CM terminals.



Connecting 230 VAC with 115 VAC selected will result in damage to the instrument as well as endanger personnel. Connecting AC power when meter is set up for DC power will result in damage to the instrument as well as endanger personnel.

Connect power to terminals L2(V-) and L1(V+) and Earth Ground to screw terminal marked with Ground symbol on screw terminal connector J2, located near the transformer on the Main Board. See Figure 3.

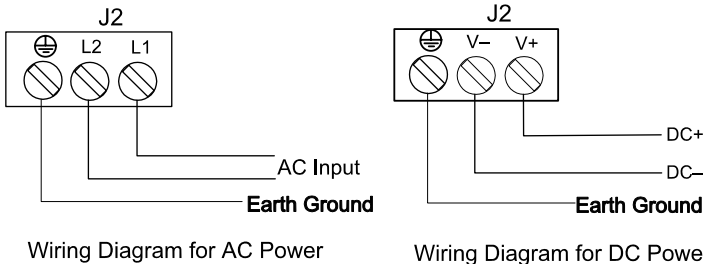

Figure 5. Input Power Connections

Notice:

- Primary voltages must not be accessible to the user.
- Primary wires must be installed in accordance to the applicable standards.
- Keep the primary wires separated from signal cables.

Signal Connections

Signal connections are made to a 10-position connector J1 on the Main Board. This connector also includes connections for Enter, Acknowledgement, Reset Total, and Common. Refer to Figure 3 for location of J1.

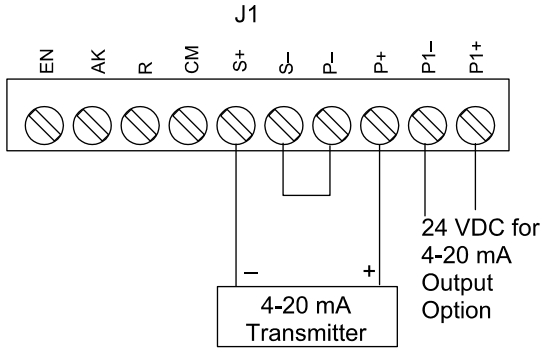

Figure 6. Two-Wire Transmitter Powered by Meter

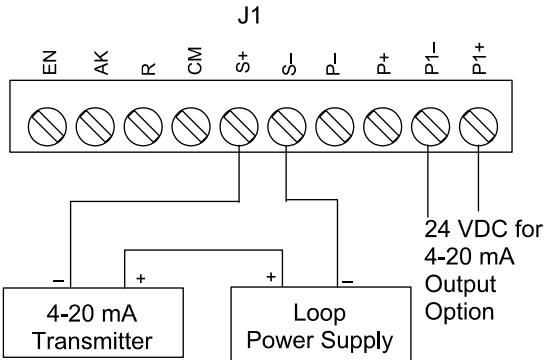

Figure 7. Two-Wire Transmitter Powered by External Supply

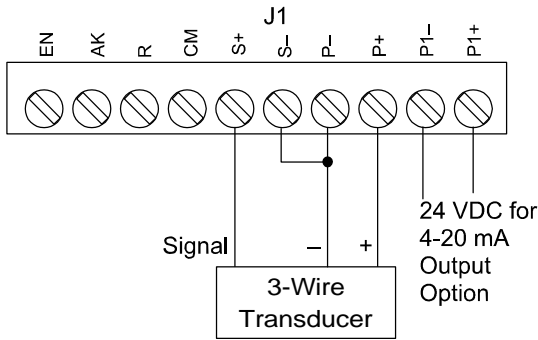

Figure 8. Three-Wire Transducer Powered by Meter

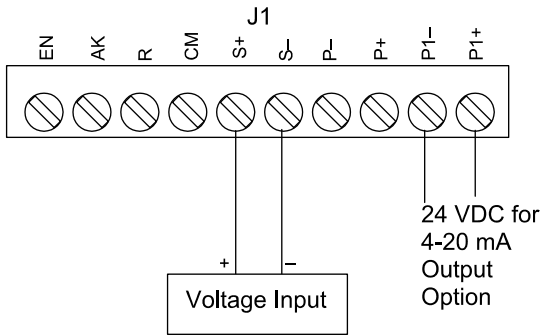

Figure 9. Direct Voltage Signal Connections

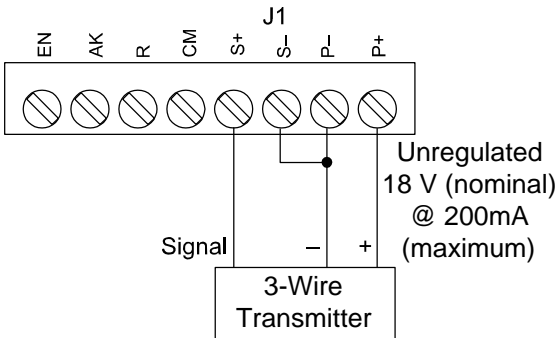

Figure 10. Optional Unregulated Supply Connections

Enter, Acknowledgement, and Reset Total Connections

Enter, acknowledgement, and reset total terminals provide a convenient method to remotely access the following functions:

Terminal	Function
EN	Programs meter via the front panel menu
AK	Acknowledges or resets relays, exit menu scroll
R	Resets total to zero

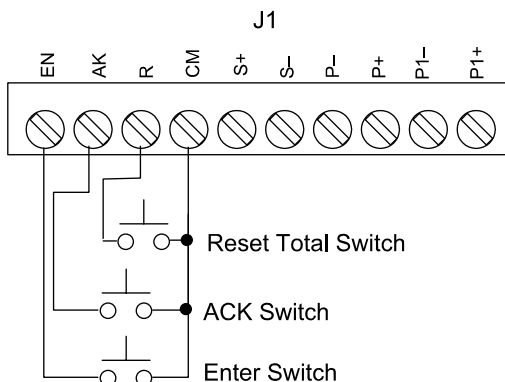

Figure 11. External Control Connections

Optional Relays & 4-20 mA Output Terminals

Depending on the model number, the Options Board may contain 2 or 4 relays and an isolated 4-20 mA output transmitter. Relay connections are made to removable screw terminal connectors located at J3 and J4 on the Option Board. Connections for the isolated 4-20 mA output option are made to J1 on the Options Board. Refer to Figure 4, page 22 for connectors' location.

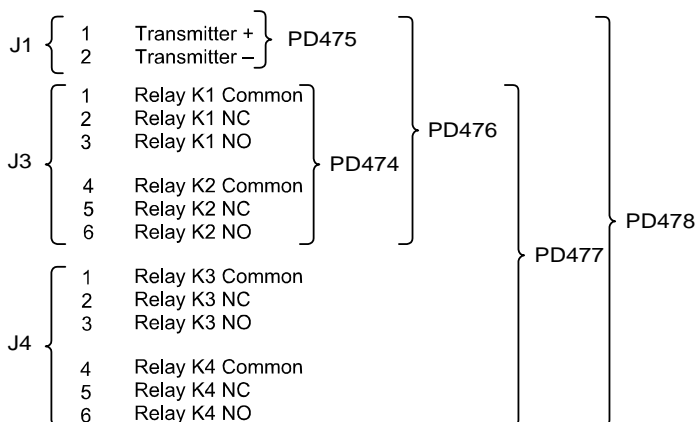

Figure 12. Relay and 4-20 mA Output Terminals

Isolated 4-20 mA Output Option Connections

The meter can be equipped with an isolated 4-20 mA output signal option that can be programmed to produce a 4-20 mA output for virtually any process/rate display with at least a 501 count span.

The meter can power both the input loop and the isolated 4-20 mA output loop. The following diagrams illustrate the 4-20 mA output signal being powered from the meter's internal power supply (AC powered units only) and by an external power supply.

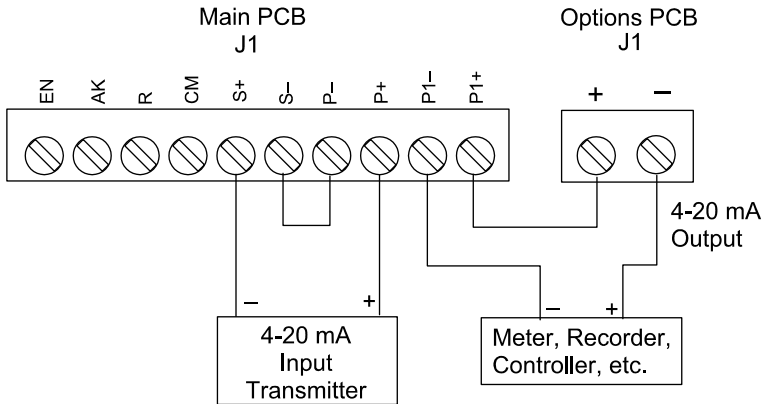

Figure 13. Both Input and Output Loops Powered by Meter

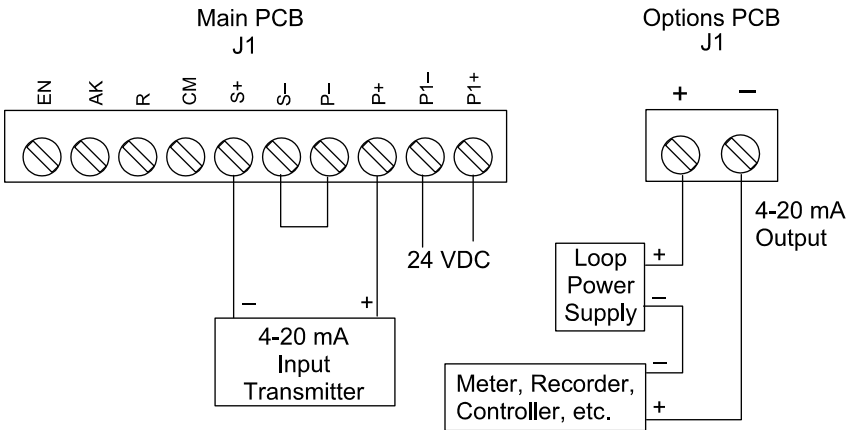

Figure 14. Input Loop Powered by Meter, Output Loop Powered from External Supply



If the output loop is powered by an external supply, the loop power supply must be turned on before the meter is turned on. Otherwise, the output loop signal may be incorrect.

Programming

Overview

The meter is programmed using the **ENTER** button and three jumper arrays. The **ENTER** button is used to calibrate the meter, program various totalizer functions, and set alarm trip and reset points. The jumper arrays are used for programming the input signal, lockout, relays acknowledge enable, and relays fail-safe operation. This section of the manual deals with programming the following aspects of the meter:

- Basic Meter
- Process/Rate Meter
- Totalizer
- Batch Controller
- Relays
- 4-20 mA Output
- Lockout and Display Selection

General Programming Description

All programming is performed using the **ENTER** button. To set up a function there are sequential steps that have to be performed. As each step progresses, either a single digit or the entire display will flash. The flashing digit, or flashing display, will be looking for acknowledgement if it is the desired digit or display. Pressing the **ENTER** button will accept the value. If the flashing display or digit is not the one desired, wait and the value will change.

Each digit will flash for 3 seconds before it starts to change, when it is accepted the next digit will flash for 3 seconds. This procedure will continue until the **ENTER** button is pressed while the desired option is flashing. As the programming progresses there will be times when a decision has to be made, an example is yes or no (**Y** or **n**).

ENTER and ACK Functionality

The **ENTER** button is used to program the meter for various functions.

The **ACK** button is used to acknowledge the relays during operation and to quit main menu scroll during programming, diagnostic menu, and calibration.

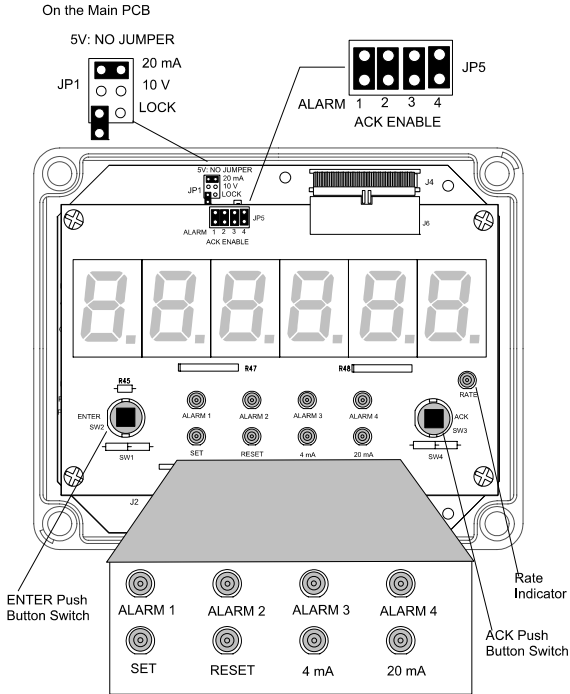

Figure 15. Jumper Arrays and Status LED Identification

ENTER Button

The **ENTER** button is used to program the meter for various functions and is located behind the front panel on the Display Board, It is labeled SW2 in Figure 15 above. The **ENTER** button can also be accessed by wiring a normally open pushbutton switch across terminals EN and CM on connector J1 located on the Main Board (see Figure 3, page 21).

Jumper Arrays Function and Location

Jumper Array Function	Label	Location	Diagram
Input signal and Lockout	JP1	Main Board	Figure 3
Relay ACK enable	JP5	Display Board	Figure 15
Fail-safe	J5	Options Board	Figure 4

Five Basic Digit/Display Setting Instructions

1. If the flashing display is OK, to accept it, press **ENTER** before it stops flashing.
2. If the flashing display is not OK, (or if **ENTER** was not pressed in time to accept it), wait for the first digit to flash.
3. If a flashing digit is OK, to accept it, press **ENTER** before it starts to scroll.
4. If a flashing digit is not OK, (or if **ENTER** was not pressed in time to accept it) wait for that digit to scroll, and press **ENTER** when OK.
5. Digits will scroll until **ENTER** is pressed. When a digit is accepted by pressing **ENTER**, the next digit flashes.

The display will scroll through the following functions in the order shown:

Display	Type of Function
<i>dSPY r</i> or <i>dSPY t</i>	Displays process/rate or display total.
<i>rSEt t</i>	Resets total to zero.
<i>dSPY P</i>	Displays and hold peak reading.
<i>CAL Ib</i> or <i>SCALE</i>	Calibrates meter after setting it for external or internal calibration.
<i>CutoffF</i>	Sets low-flow cutoff point.
<i>t bRSE</i>	Sets time base.
<i>tot CF</i>	Sets totalizer conversion factor.
<i>tot dP</i>	Sets totalizer decimal point.
<i>SEtUP</i>	Sets set points for rate or total, latching or non-latching relays.
<i>SEtPtS</i>	Sets alarms set/reset points and batch presets.
<i>outPut</i>	Sets 4-20 mA output values, if option is installed.
<i>dSPLY</i>	Includes or excludes menu titles from scroll.
<i>d IAG</i>	Displays parameter settings one at a time for diagnostic purposes.

To quit main menu, calibration, or scaling press **ACK** while displaying main menu item or while display is flashing input n (*INPt n*) or display n (*dSPY n*), where n is the input or display number.

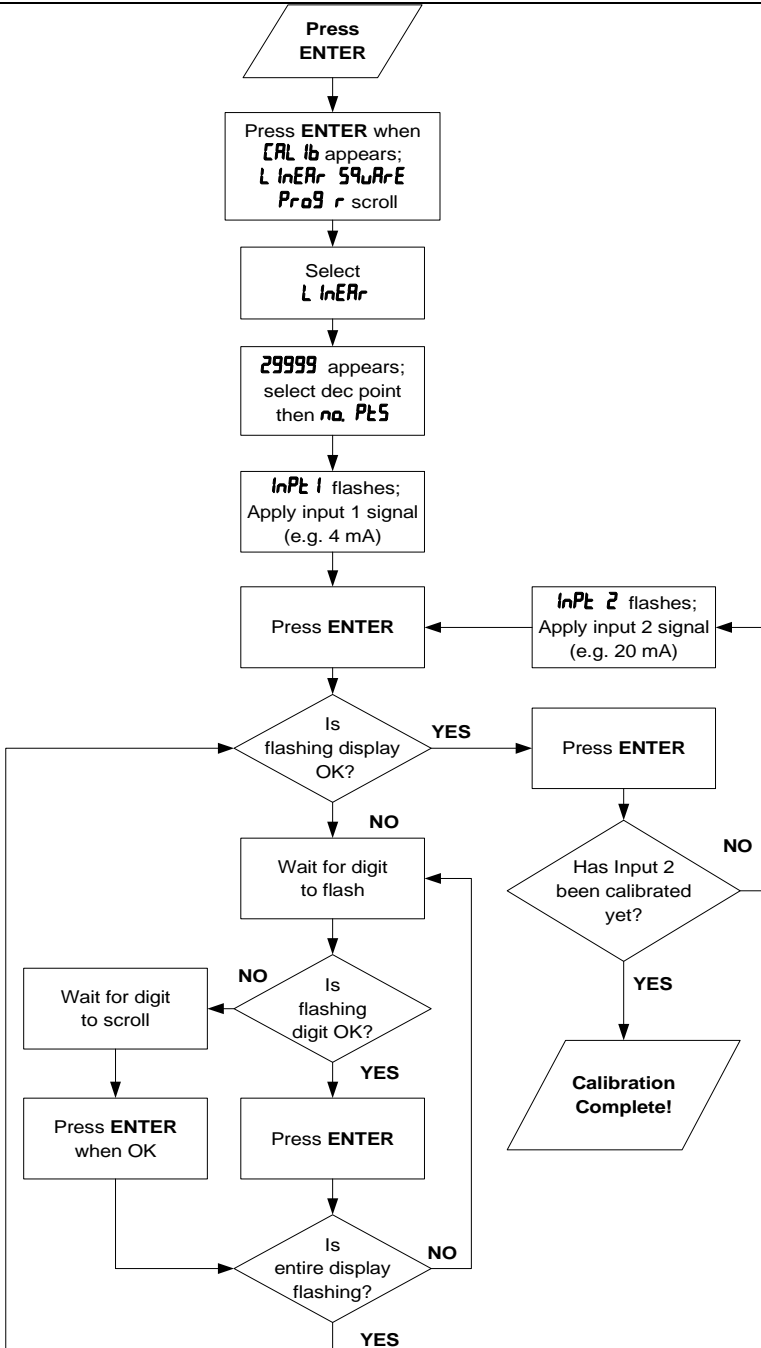

Figure 16. Two-Point Calibration Flowchart

Basic Meter Programming

Overview

The meter is programmed using three jumper arrays and the **ENTER** button. The **ENTER** button is used to calibrate the meter, program various totalizer functions, and set alarm set and reset points. The jumper arrays are used for programming the input signal, lockout, relay fail-safe operation, and relay acknowledge enable. If the optional relay Board is installed, it is best to program the fail-safe jumper (J5 on Options Board) for the desired operation before reassembling the Display Board because this jumper is not accessible once the Display Board is installed. There are four steps for programming the basic meter functions:

1. Select Input
2. Perform Initial Calibration if Needed
3. Select Calibration Method
4. Calibrate or Scale the Meter

Select Input Signal

The meter can be programmed to accept all of the common process signals, such as 4-20 mA, 1-5 V, 0-5 V, and 0-10 V using jumper array JP1 located on the Main Board, to the right of the transformer.

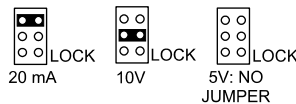

Figure 17. JP1 Input Signal Selection Array.

The meter can also be programmed to restrict personnel from making changes to the meter's programming by installing a jumper over LOCK pins. For a complete description of the **Lockout and Display Selection Programming** features, see page 60.

Reassemble the Display Board

After the wiring and jumper selections have been made, reassemble the Display Board.

The remaining setup and programming operations are performed with the **ENTER** button.

If the meter contains relays, there is a fail-safe jumper (J5) that should be addressed prior to reassembling the Display Board. Refer to the section **Set Relays for Fail-Safe Operation** on page 48, for how to program this function of the meter. This jumper is not accessible once the Display Board is in place.

To install the Display Board (see Figure 1, page 18):

1. Align the Display Board mounting holes with Main Board standoffs.
2. Screw in the four screws.
3. Tighten all screws.

Select Calibration Method

For best results, allow the meter to warm up for at least 30 minutes.

The meter may be calibrated using an external signal source such as a calibrator or scaled using the internal source with the **I-CAL** feature. With **I-CAL**, a 4-20 mA input can be scaled for any display range without applying a signal. To scale inputs such as 0-5 V, 1-5 V, or 0-10 V without applying a signal, it is necessary to first complete an Initial Calibration (see **Initial Calibration With External Source (if Needed)**) below.

To select Calibration Method, apply power with **ACK** button pressed.

1. When display stops flashing, release **ACK** button. Display alternates between **E-CAL** and **I-CAL**.
2. To calibrate meter with an external source, such as a calibrator, press **ENTER** when **E-CAL** appears.

To scale meter with internal source, press **ENTER** when **I-CAL** appears.

Initial Calibration With External Source (if Needed)

For best results, allow the meter to warm up for at least 30 minutes. Initial calibration is required only when the **I-CAL** feature is to be used with an input other than the default 4-20 mA range or it is time for recalibration.









1. Make sure the jumper on JP1, is set for the desired input (see Figure 17, page32).
2. Apply power with **ENTER** and **ACK** buttons pressed. Release when display stops flashing.
3. The meter scrolls through the choices **SEL 20**, **SEL 5**, and **SEL 10**, which correspond to select input signals of 4-20 mA, 0-5 V or 1-5 V, and 0-10 V. Press **ENTER** when desired value appears.
4. The meter flashes **InPt 1**. Apply low-end signal, (4 mA or 0 V), press **ENTER**.
(For 1-5 V input signals calibrate meter with input 1 = 0 V, input 2 = 5 V.)
5. The meter flashes **InPt 2**. Apply high-end signal (20 mA, 5 V, 10 V), press **ENTER**.
6. This completes the Initial Calibration and initializes input 1 and input 2 scaling points to 4.000 & 20.000 mA, 0.000 & 5.000 V, or 0.000 & 10.000 V.

Scale or Calibrate the Meter

The meter may be scaled without applying an external signal source or calibrated by applying an external signal source.

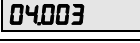
Scale Using Internal Calibration (I-CAL)

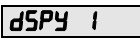
<p>Note To simplify programming, write down the desired programming values prior to attempting to program the meter. The Programmed Parameter Settings form located at the back of this manual provides a convenient method to record the user settings; it also provides the factory setting for most of the programmable parameters.</p>	
<p>Press ENTER, then press it again when the scale (SCALE) function appears.</p>	
<p>Select calibration/scaling function</p> <p>The display will show L InERr for linear, SQuRrE for square root, and Pro9 r for programmable root extraction.</p> <p>To select a function, press ENTER when desired function is displayed. The meter advances to setting the decimal point for process/rate.</p> <p>The programmable root function is used for open channel flow measurement using weirs and flumes.</p>	<p>L InERr</p> <p>then</p> <p>SQuRrE</p> <p>then</p> <p>Pro9 r</p>
<p>Select linear input</p> <p>To select linear, press ENTER when L InERr is displayed. The meter will now advance to setting the decimal point for process/rate.</p>	<p>L InERr</p>
<p>Set the process/rate decimal point</p> <p>The decimal point will begin to scroll, and a zero will be displayed for the sixth digit. Select decimal point location or extra zero by pressing ENTER when decimal point is in the required location or extra zero is displayed. If no decimal point is required, press ENTER when the decimal point is not shown.</p>	<p>29999</p> <p>then</p> <p>299990</p> <p>then</p> <p>29999</p> <p>then</p> <p>29.999</p>
<p>Select the number of calibration points</p> <p>If ENTER is not pressed when na. Pt5 is displayed, the number of points will default to whatever was selected previously. To program the number of calibration points, press ENTER while na. Pt5 is flashing. The current setting for the number of points will flash. If this is the desired value, press ENTER to accept it. If not, wait and the number will increase. When the desired number of points is displayed, press ENTER to accept it.</p>	<p>na. Pt5</p> <p>then</p> <p>2</p> <p>then</p> <p>3</p> <p>....</p> <p>11</p>

<p>Set the first calibration point</p> <p>Input 1 (<i>InPt 1</i>) flashes indicating that the meter is ready to be programmed for the input for the first calibration point. Press ENTER.</p>		
<p>Set the input for the first calibration point</p> <p>The entire display will flash for three seconds. For instructions see <i>Five Basic Digit/Display Setting Instructions</i>, page 30.</p>		 <p>then</p>  <p>final input 1</p> 
<p>Set the display for the first calibration point</p> <p>Display 1 (<i>dSPY 1</i>) flashes indicating that the meter is ready to be programmed for the display for the first calibration point. Press ENTER.</p>		
<p>Program the display for display 1 (<i>dSPY 1</i>) as described above when the input for the first calibration point was programmed.</p>		 <p>final display 1</p> 







To quit main menu, calibration, or scaling press **ACK** while displaying main menu item or while display is flashing input n (InPt n) or display n (dspy n), where n is the input or display number.



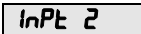

Minimum Input Span (Error Message)

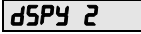

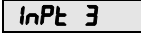

The calibration input signals must be within the range of the meter and input 2 must be greater than input 1. However, the display for input 2 does not have to be greater than the desired display for input 1.

If input 1 signal and input 2 signals are too close together an **Error** message will appear and the display will return to the current input to be calibrated. To terminate calibration process, press ACK button.

Input Range	Minimum Difference Between Input 1 & Input 2
0-5 V	0.16 V
0-10 V	0.32 V
4-20 mA	1.60 mA

<p>Set the second calibration point</p> <p>Input 2 (<i>InPt 2</i>) flashes indicating that the meter is ready to be programmed for the input for the second calibration point. Press ENTER.</p>		
<p>Set the input for the second calibration point</p> <p>Program the display for input 2 (<i>InPt 2</i>) as described above when the input for the first calibration point was programmed.</p>		 then 
<p>Set the display for the second calibration point</p> <p>Display 2 (<i>dSPY 2</i>) flashes indicating that the meter is ready to be programmed for the display for the second calibration point. Press ENTER.</p>		
<p>Program the display for display 2 (<i>dSPY 2</i>) as described above when the input for the first calibration point was programmed.</p>		 final display 2 
<p>Set the display for the remaining calibration points</p> <p>If other calibration points were selected, they will be displayed and can be set according to the procedure for the first two points.</p> <p>When the display for the last calibration point is accepted by pressing ENTER, the meter will display total or process/rate.</p>		





<p>Select square root</p> <p>To select square root, press ENTER when function is displayed. The meter will now advance to setting the decimal point.</p>	
<p>Set the process/rate decimal point</p> <p>The decimal point will begin to scroll, and a zero will be displayed for the sixth digit. Select decimal point location or extra zero by pressing ENTER when decimal point is in the required location or extra zero is displayed. If no decimal point is required, press ENTER when the decimal point is not shown.</p>	 final 
<p>Follow programming procedure outlined for 2 point linear input calibration.</p>	

<p align="center">Select programmable root</p> <p>To select programmable root, press ENTER when function is displayed. The meter will now advance to setting the exponent value.</p>	<p align="center">Prog r</p>
<p align="center">Program exponent</p> <p>Program exponent value. Exponent value must be greater than 1.0000 and smaller than 3.0000. Exponent decimal point is fixed.</p>	<p align="center">16070</p>
<p align="center">Set the process/rate decimal point</p> <p>The decimal point will begin to scroll, and a zero will be displayed for the sixth digit. Select decimal point location or extra zero by pressing ENTER when decimal point is in the required location or extra zero is displayed. If no decimal point is required, press ENTER when the decimal point is not shown.</p>	<p align="center">29999</p> <p align="center">final</p> <p align="center">29.999</p>
<p align="center">Set the first calibration point</p> <p>Input 1 (InPt 1) flashes indicating that the meter is ready to be programmed for the input for the first calibration point. Press ENTER.</p>	<p align="center">ENTER</p>  <p align="center">InPt 1</p>
<p align="center">Set the input for the first calibration point</p> <p>The entire display will flash for three seconds. Set input 1 value. Input 1 value must be the signal value at which the calculated flow rate is equal to zero.</p>	<p align="center">04000</p>
<p align="center">Set the display for the first calibration point</p> <p>Display 1 (dSPY 1) flashes indicating that the meter is ready to be programmed for the display for the first calibration point. Press ENTER.</p>	<p align="center">ENTER</p>  <p align="center">dSPY 1</p>
<p>Program display 1 value. Display 1 must be set to zero for accurate root extraction calculation.</p>	<p align="center">00.000</p>
<p align="center">Set the second calibration point</p> <p>Input 2 (InPt 2) flashes indicating that the meter is ready to be programmed for the input for the second calibration point. Press ENTER.</p>	<p align="center">ENTER</p>  <p align="center">InPt 2</p>
<p align="center">Set the input for the second calibration point</p> <p>Program the display for input 2 (InPt 2) as described above when the input for the first calibration point was programmed.</p>	<p align="center">20.000</p>
<p align="center">Set the display for the second calibration point</p> <p>Display 2 (dSPY 2) flashes indicating that the meter is ready to be programmed for the display for the second calibration point. Press ENTER.</p>	<p align="center">ENTER</p>  <p align="center">dSPY 2</p>
<p>Program display 2 value. Display 2 must be set to the flow rate at the maximum head of the weir or flume.</p>	<p align="center">18702</p>

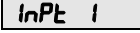

Programmable exponent function described above for **scale** menu applies to **calibrate** menu as well. To quit main menu, calibration, or scaling press **ACK** while displaying main menu item or while display is flashing input n (**InPt n**) or display n (**dspy n**), where n is the input or display number.

Calibrate Using External Calibration (E-CAL)

<p>Note To simplify programming, write down the desired programming values prior to attempting to program the meter. The Programmed Parameter Settings form located at the back of this manual provides a convenient method to record the user settings; it also provides the factory setting for most of the programmable parameters.</p>	
<p>Press ENTER, then press it again when the calibrate (CAL Ib) function appears.</p>	 <div style="border: 1px solid black; padding: 2px; display: inline-block; margin-top: 10px;">CAL Ib</div>
<p style="text-align: center;">Select calibration/scaling function</p> <p>The display will show L InERr for linear, SqURrE for square root, and PrOg r for programmable root extraction. To select a function, press ENTER when desired function is displayed. The meter advances to setting the decimal point for process/rate. The programmable root function is used for open channel flow measurement using weirs and flumes.</p>	<div style="border: 1px solid black; padding: 2px; display: inline-block; margin-bottom: 5px;">L InERr</div> <p style="text-align: center;">then</p> <div style="border: 1px solid black; padding: 2px; display: inline-block; margin-bottom: 5px;">SqURrE</div> <p style="text-align: center;">then</p> <div style="border: 1px solid black; padding: 2px; display: inline-block;">PrOg r</div>
<p style="text-align: center;">Select linear input</p> <p>To select linear, press ENTER when L InERr is displayed. The meter will now advance to setting the decimal point for process/rate.</p>	<div style="border: 1px solid black; padding: 2px; display: inline-block;">L InERr</div>
<p style="text-align: center;">Set the process/rate decimal point</p> <p>The decimal point will begin to scroll, and a zero will be displayed for the sixth digit. Select decimal point location or extra zero by pressing ENTER when decimal point is in the required location or extra zero is displayed. If no decimal point is required, press ENTER when the decimal point is not shown.</p>	<div style="border: 1px solid black; padding: 2px; display: inline-block; margin-bottom: 5px;">29999</div> <p style="text-align: center;">then</p> <div style="border: 1px solid black; padding: 2px; display: inline-block; margin-bottom: 5px;">299990</div> <p style="text-align: center;">then</p> <div style="border: 1px solid black; padding: 2px; display: inline-block; margin-bottom: 5px;">2.9999</div> <p style="text-align: center;">then</p> <div style="border: 1px solid black; padding: 2px; display: inline-block;">29.999</div>
<p style="text-align: center;">Select the number of calibration points</p> <p>If ENTER is not pressed when no. Pt5 is displayed, the number of points will default to whatever was selected previously. To program the number of calibration points, press ENTER while no. Pt5 is flashing. The current setting for the number of points will flash. If this is the desired value, press ENTER to accept it. If not, wait and the number will increase. When the desired number of points is displayed, press ENTER to accept it.</p>	<div style="border: 1px solid black; padding: 2px; display: inline-block; margin-bottom: 5px;">no. Pt5</div> <p style="text-align: center;">then</p> <div style="border: 1px solid black; padding: 2px; display: inline-block; margin-bottom: 5px;">2</div> <p style="text-align: center;">then</p> <div style="border: 1px solid black; padding: 2px; display: inline-block; margin-bottom: 5px;">3</div> <p style="text-align: center;">....</p> <div style="border: 1px solid black; padding: 2px; display: inline-block;">11</div>

<p>Apply the signal for the first calibration point Input 1 (<i>InPt 1</i>) flashes indicating that the meter is ready to accept a signal for the first calibration point. Apply the desired signal, typically 4 mA, and press ENTER.</p>		
<p>Set the display for the first calibration point The entire display will flash for three seconds. For instructions see <i>Five Basic Digit/Display Setting Instructions</i>, page 30.</p>		 then  then  final 

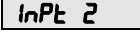
If an error message is displayed during calibration, refer to *Minimum Input Span (Error Message)*, page 35.

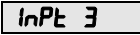
<p>Apply signal for the second calibration point Input 2 (<i>InPt 2</i>) flashes indicating that the meter is ready to accept a signal for the second calibration point. Apply the desired signal, typically 20 mA, and press ENTER.</p>		
<p>Set the display for the second calibration point Program the display as described above when the display for the first calibration point was programmed.</p>		 final display 
<p>Set the display for the remaining calibration points If other calibration points were selected, they will be displayed and can be set according to the procedure for the first two points. When the display for the last calibration point is accepted by pressing ENTER, the meter will display total or process/rate.</p>		

Round Horizontal Tank Calibration Points

Number of Points: 10		Maximum Error: 0.3% F.S.
Input	mA	Display (% Volume)
1	4.00	0.00
2	4.80	1.80
3	6.00	7.20
4	7.20	14.20
5	9.20	28.10
6	14.80	71.80
7	16.80	85.80
8	18.00	92.80
9	19.20	98.10
10	20.00	100.00

Number of Points: 8		Maximum Error: 0.5% F.S.
Input	mA	Display (% Volume)
1	4.00	0.00
2	4.80	1.90
3	6.40	9.50
4	8.40	22.40
5	15.60	77.70
6	17.60	90.50
7	19.20	98.10
8	20.00	100.00

Calibration Error (*Error*)

A meter display of **Error** during calibration indicates that the calibration process was not successful. The meter should be recalibrated.

The **Error** message will appear if input 1 signal and input 2 signal are too close together. Refer to **Minimum Input Span (Error Message)**, page 35.

The **Error** message will appear if input 1 signal is inadvertently also applied for input 2 calibration, or **ENTER** is pressed before applying input 2.









Rate Meter Programming

Overview

The meter can also be used to display flow rate. In addition to the scaling and calibration procedures described above, the only setup required for this is setting the meter to display rate, and programming the low-flow cutoff if required.

Set Display to Rate (dSPY r)



The user may select either process/rate or total to be set as the default displayed reading. When displaying process/rate, the process/rate LED indicator will be illuminated.

<p>To change the display from reading total to rate</p> <p>Press ENTER to begin scrolling through the functions.</p>	 <p>PRECISION DIGITAL </p> <p>346253</p> <p><input type="checkbox"/> ENTER <input type="checkbox"/> ACK</p>
<p>When display rate (dSPY r) appears, press ENTER.</p>	  <p>PRECISION DIGITAL </p> <p>dSPY r</p> <p><input type="checkbox"/> ENTER <input type="checkbox"/> ACK</p>
<p>The meter now displays rate and the green "R" LED on the right side is illuminated.</p>	 <p>PRECISION DIGITAL </p> <p>4.56 </p> <p><input type="checkbox"/> ENTER <input type="checkbox"/> ACK</p>

Low-flow Cutoff Programming (Cutoff)

The low-flow cutoff feature allows the meter to be programmed so that the often-unsteady output from a differential pressure transmitter at low-flow rates always displays zero on the meter.

The totalizer in the meter accumulates based on the rate display. This means that when the rate display is zero, even as a result of the low-flow cutoff, the totalizer will not accumulate.

<p>To set the low-flow cutoff point Press ENTER, then press it again when low-flow cutoff (Cutoff) appears.</p>		
<p>The entire display will flash for three seconds. For instructions see Five Basic Digit/Display Setting Instructions, page 30. NOTE: To disable the low-flow cutoff, reprogram the value to zero.</p>		

Totalizer Programming



Overview

The meter can also be used to display total flow. There are five functions to be programmed to allow the meter to act as a flow totalizer:

1. Set Display to Total
2. Set Rate Time Base
3. Set Totalizer Conversion Factor
4. Set Totalizer Decimal Point
5. Set Alternating Display (if Needed)







Set Display for Total (dSPY t)

The user may select either process/rate or total to be set as the default displayed reading. When displaying process/rate, the green process/rate LED indicator will be illuminated.

<p>To change the display from reading rate to total</p> <p>The meter is now displaying rate, as indicated by the green "R" LED illuminated on the right side of the display . Press ENTER to begin scrolling through the functions.</p>	
<p>When display total (dSPY t) appears, press ENTER.</p>	
<p>The meter now displays total.</p>	

Set Rate Time Base (t bASE)

To act as a totalizer, the meter must be programmed with the same time base as the flow transmitter. The time base is the time unit in which the rate is displayed. For example, if the rate is in gallons per hour then the time base must be set to **Hour**.

<p>To set the time base Press ENTER, then press it again when the time base (t bASE) function appears.</p>		
<p>The different units of time will scroll: minute, hour, day, and second. Press ENTER when the required unit is displayed.</p>	 or  or  or 	

Set Totalizer Conversion Factor (tob CF)

The totalizer conversion factor is a number that is multiplied by the rate to compute the total. For example, if the rate display is gallons per hour and total is desired in barrels, (1 gallon = 0.02381 barrels) a total conversion factor of 0.02381 should be used. If the rate display is gallons per hour and total is desired in gallons, a factor of 1 should be used.

The conversion factor has a selectable decimal point. Because the decimal point is mathematically significant, values such as 1.0000, 1.0, and 1 produce identical results. However, values such as 1.1111, 1.1, and 1 produce different results. The decimal point should be set so as to produce the best resolution for the application. The maximum value for the totalizer conversion factor depends upon the decimal point selection.

Number of Decimal Places	Maximum Conversion Factor
0	59999
1	5999.9
2	599.99
3	59.999
4	5.9999
5	0.59999

<p>Set totalizer conversion factor Press ENTER, then press ENTER again when the totalizer conversion factor (tot CF) function appears.</p>		<p>tot CF</p>
<p>Set the totalizer conversion factor decimal point Immediately after tot CF is selected, the display will show six numbers. After three seconds, the decimal point will begin to scroll. Select the desired decimal point location by pressing ENTER when the decimal point is in the desired location. If no decimal point is required press ENTER when the decimal point is not shown.</p>		<p>999999 then 999999 then .999999 final 9.999999</p>
<p>Set the total conversion factor value The entire display will flash for three seconds. For instructions see <i>Five Basic Digit/Display Setting Instructions</i>, page 30.</p>		<p>00 1000 then 002000 then 002380 final 002381</p>







Set Totalizer Decimal Point (tot dP)

The totalizer decimal point may be set independently of the rate decimal point. For instance, it is possible to have a rate decimal point set at 100.0 and a totalizer decimal point set at 45.673.

<p>Set totalizer decimal point Press ENTER, then press it again when the totalizer decimal point (tot dP) function appears.</p>		<p>tot dP</p>
<p>Immediately after tot dP is selected, the display will show six numbers. After three seconds, the decimal point will begin to scroll. Select the desired decimal point location by pressing ENTER when the decimal point is in the desired location. If no decimal point is required press ENTER when the decimal point is not shown.</p>		<p>999999 then .999999 final 999999</p>

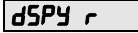
Set Alternating Total/Rate Display

The display may be programmed to automatically toggle between rate and total every ten seconds. To set up the alternating display select no (n) for both, display rate (dSPY r) and display total (dSPY t) under **Display Selection (dSPLY)**.

<p>Set alternating total and rate display Press ENTER, then press it again when display (dSPLY) function appears.</p>		
<p>Press ENTER when display rate (dSPY r) appears</p>		
<p>Yes or no (y or n) will flash alternately. Press ENTER when n appears.</p>		
<p>Press ENTER when display total (dSPY t) appears</p>		
<p>Yes or no (y or n) will flash alternately. Press ENTER when n appears.</p>		
<p>Note: Selections made through the display menu (dSPLY) can be made with or without the lockout jumper installed, but only become active when the lockout jumper is installed.</p>		

This completes calibration and setup of the Basic Meter and Totalizer.

Parameter Combinations Resulting in Error Message (Error 1)

Certain extreme combinations of parameter selections may exceed the totalizer range of the meter. If this occurs, the meter will momentarily display **Error 1** immediately after a programming operation. Steps to correct this situation are:

Increase the number of decimal places in rate or totalizer conversion factor.

or

Decrease the number of decimal places in total.

or

Increase the time base from Second to Minute, Minute to Hour, or Hour to Day.

Set Point Setup and Programming

Overview

The meter is available with 4 alarm points and corresponding front panel status LEDs as a standard feature. The front panel LEDs are useful for alarm applications that require visual notification only. For applications that require relay contacts, such as driving external alarm devices or batch controlling, the meter can be equipped with either two or four relays. Any of these relays may be assigned to process/rate or total.

Programming the relays involves four steps:

1. Setting the relay manual reset (ACK Enable) jumpers:
These jumpers (JP5) are located on the Display Board and determine if a relay can be manually reset.
2. Setting the fail-safe jumper (J5):
Fail-safe mode (default): In the alarm condition, the NC contacts are connected to the Common contacts of the relays. The fail-safe operation can be disabled, by removing jumper J5 located on the Options Board.
3. Setting set point functions using **SEtUP** menu:
 - a. Selecting set points for process/rate or total.
 - b. Selecting latching or non-latching relay action for process/rate set points.
 - c. Selecting preset offset for total set points.
 - d. Selecting internal or external (**I** or **E**) total reset for batch control applications.
 - e. Programming delay on release from 1 to 999 seconds if internal total reset (**I**) has been selected.
 - f. Selecting pump alternation control feature for non-latching relays.
4. Programming set, reset, preset, offset, and delay values using the **SEtPt5** menu:
 - a. Set and reset points for alarms (set points) assigned to process/rate (thus determining high or low alarm status and deadband).
 - b. Preset values for set points assigned to total.
 - c. Preset offset values for set points assigned to total with offset selected.

Note: See **Specifications** section for description of these functions.

Set Relays for Manual or Automatic Reset

Jumper array JP5 located on the Display Board is used to program the relays so they can be reset manually. See Figure 15 on page 29 for location of this jumper array. This jumper array, in combination with **SEtUP** functions of latching or non-latching for process/rate and internal or external total reset, provide multiple relay reset modes:

Relays Assigned to Total		
Type of Reset	JP5 Jumper Position	SEtUP Menu
Automatic after delay elapses	N/A	Internal (I)
Automatic when total resets to zero + manual any time	On	External (E)

Relays Assigned to Rate		
Type of Reset	JP5 Jumper Position	SEtUP Menu
Automatic only after passing reset point	Off	Non-latching
Automatic + manual at any time	On	Non-latching
Manual only at any time	On	Latching
Manual only after passing reset point	Off	Latching

Set Relays for Fail-Safe Operation

In the fail-safe mode, the relay coils are **energized** and the Normally Open (NO) contacts are connected to the Common (C) contacts under normal operation. During an alarm condition, the relay coils are **de-energized**, the Normally Closed (NC) contacts are connected to the Common (C) contacts. During a power failure the relay contacts reflect an alarm condition.

Removing jumper J5 disables the fail-safe operation. J5 is located on the Options Board next to J2 connector (see Figure 4, page 22). If fail-safe mode is disabled, the operation of the relay contacts is opposite to the one described in the previous paragraph.



Assigning Set Points to Process/Rate or Total (SEtUP)

The optional relays can be assigned to respond to the process/rate or the accumulated total using the **SEtUP** function. Process/rate relays may be set for latching or non-latching operation. Total relays may be programmed for manual or automatic reset after a programmable delay on release has elapsed. Delay on release is available when internal total reset is selected. The internal total reset function is applied to the highest programmed preset value.

The **SEtUP** menu is used to program the following:

1. Selecting a set point for process/rate or total
Any set point can be set up so it responds to the process/rate or total display.
2. Latching or non-latching relay action for process/rate set points
Any process/rate set point can be set up so it functions as a latching or non-latching relay. In latching mode, the relay must be reset via the front panel ACK button or an external switch wired across terminals AK and CM at J1 connector on the Main Board.
3. Internal or external total reset effect on total relays
If internal total reset is selected, the total resets to zero when the highest preset value is reached. All relays assigned to total will automatically reset after the delay on release elapses, allowing a new batch to begin.
If external total reset is selected, relays must be reset manually. Total relays also reset when total is reset to zero.
4. Preset offset for total set points
Relays that are assigned to total can be programmed to trip at any point below the next relay's preset value. If preset offset mode is selected the corresponding relay will always trip at a programmed offset value before the next relay trips. When an offset value is being programmed, the corresponding status LED flashes.
Example: Set point 1 and 2 are set up for total, with offset selected (under set point 2). If the preset offset is set at 10, (during set points programming for set point 1), then relay 1 will trip 10 counts before relay 2.
5. Program delay on release from 1 to 999 seconds if internal total reset has been selected.
If internal total reset is selected, the total is automatically reset to zero when the highest preset is reached, then a delay will occur before all total relays reset automatically. The delay can be programmed anywhere from 1 to 999 seconds. Once the delay has started, the ACK button becomes inoperative for all total relays until the delay has elapsed.
6. Setup process/rate relays for pump alternation control.
A pair of relays can be set up to alternate every time an on/off pump cycle is completed. Set points and reset points can be programmed, so that first pump on is the first pump off.

Rate or Total, Latching or Non-Latching Relays

<p>Note To simplify programming, write down the desired programming values prior to attempting to program the meter. The Programmed Parameter Settings form located at the back of this manual provides a convenient method to record the user settings; it also provides the factory setting for most of the programmable parameters.</p>		
<p>Press ENTER, then press ENTER again when the setup (SEtUP) function appears</p>		<p>SEtUP</p>
<p style="text-align: center;">To set up set points</p> <p>Set point 1 (SEt 1) will be displayed. Press ENTER to program set point 1 or wait and the display will move to the next set point. When set point 4 (SEt 4) is shown, the meter will exit the setup (SEtUP) menu and move to the next programming function.</p>		<p>SEt 1</p> <p>then</p> <p>SEt 2</p> <p>then</p> <p>SEt 3</p> <p>then</p> <p>SEt 4</p> <p>then</p> <p>1 or E</p>
<p>If ENTER is pressed while set point 1 (SEt 1) is shown, the display will then show rate or total (r or t) flashing alternately. Select the desired one by pressing ENTER when it is flashing.</p>		<p>SEt 1</p> <p>then</p> <p>r or t</p>
<p style="text-align: center;">Select process/rate</p> <p>After selecting r for process/rate, the display will show latch (LAtCH). Press ENTER to program this function. If ENTER is not pressed within 3 seconds, this function will remain programmed as it was before, and the next set point will be displayed.</p>		<p>r or t</p> <p>then</p> <p>LAtCH</p> <p>then</p> <p>SEt 2</p>
<p>If ENTER is pressed while the display reads LAtCH, yes or no (y or n) will flash alternately. To program this set point for Latching relay, press ENTER when y is flashing. To program this set point for non-latching relay, press ENTER when n is flashing. After making the selection, setup of set point 1 is complete and the next set point will be displayed. Press ENTER to set up that set point, if not, wait until desired set point is displayed or wait for the meter to exit the SEtUP menu completely.</p>		<p>r or t</p> <p>then</p> <p>LAtCH</p> <p>then</p> <p>y or n</p> <p>then</p> <p>SEt 2</p>

Select total	
After selecting t for total, the display will show set point 2 (SEt 2), press ENTER to set up set point 2 or wait and the display will move to the next set point.	then

Programming the Second Set Point

The only potential difference between the way set point 2 is programmed from the way set point 1 was programmed is if set point 1 was assigned to total. If set point 1 was assigned to total, and set point 2 is also assigned to total, then the user may select offset mode after setting set point 2 for total. The offset value will be programmed during set point 1 programming, under the **SEtPt5** menu, and it corresponds to the value at which relay 1 trips before relay 2 trips. This feature is useful for some batch control applications.

If ENTER is pressed while set point 2 (SEt 2) is shown, the display will then show rate or total (r or t) flashing alternately. Select the desired one by pressing ENTER when it is flashing.		 then
Select process/rate		 then then
If ENTER is pressed while the display reads LAtCH , yes or no (y or n) will flash alternately. To program this set point for latching relay, press ENTER when y is flashing. To program this set point for Non-latching relay, press ENTER when n is flashing. After making the selection, setup of set point 1 is complete and the next set point will be displayed. Press ENTER to program that set point, if not, wait until desired set point is displayed or wait for the meter to exit the SEtUP menu completely.		 then then then
Select total when the first set point was assigned to rate		 then

<p>Select total when the first set point was assigned to total</p> <p>After selecting t for total for second set point, the display will show preset offset (OFFSEt) press ENTER to set up this function. If ENTER is not pressed within 3 seconds, this function will remain programmed as it was before, and the next set point will be displayed.</p>	<p>r or t</p> <p>then</p> <p>OFFSEt</p> <p>then</p> <p>SEt 3</p>
<p>If ENTER is pressed while the display reads OFFSEt, yes or no (y or n) will flash alternately. To program this set point for preset offset, press ENTER when y is flashing. To program this set point without preset offset, press ENTER when n is flashing. After making the selection, setup of set point 2 is complete and the next set point will be displayed. Press ENTER to set up that set point, if not, wait until desired set point is displayed or wait for the meter to exit the SEtUP menu completely.</p>	<p>OFFSEt</p> <p>then</p> <p>y or n</p> <p>then</p> <p>SEt 3</p> 
<p align="center">Setup of the remaining set points</p> <p>The remaining set points, set point 3 and set point 4 are set up in the same fashion as set point 2. They can be set up as process/rate or total set points.</p>	

Programming Internal Total Reset and Delay (dELAY)

<p>Select internal total reset and programmable delay</p> <p>The entire display will flash for three seconds. For instructions see <i>Five Basic Digit/Display Setting Instructions</i>, page 30. .</p> <p>This completes the delay on release programming.</p>	<p>t or E</p> <p>dELAY</p> <p>then</p> <p>0000 10</p> <p>final delay</p> <p>000600</p>
<p>The display moves to setting the relays for pump alternation control.</p>	

Setting Relays for Pump Alternation (ALtErn)

<p>Setting relays for pump alternation control</p> <p>At the end of the SEtUP menu, the display will show alternate (ALtErn), press ENTER to set up this function. If ENTER is not pressed within 3 seconds, this function will remain programmed as it was before, and the next menu will be displayed.</p>	<p>ALtErn</p> <p>then</p> <p>SEtPtS</p>
<p>If ENTER is pressed while display reads ALtErn, display changes to ALt rY, status LEDs 1-4 flash in pairs. To program relay pair to alternate, press ENTER when desired pair is flashing. To program relays for independent operation (not to alternate), press ENTER when all status LEDs are off. After making the selection, SEtPtS menu is displayed. Possible combinations of alternating relays: 1-2, 1-3, 1-4, 2-3, 2-4, 3-4, and none.</p> <p>Note: Only one relay pair can be set up to alternate at a time.</p>	 <p>ALtErn</p> <p>then</p> <p>ALt rY</p> <p>then</p> <p><i>Select flashing LED Pair</i></p> <p>then</p> <p>SEtPtS</p>
<p>This completes the set points setup. The display moves to the next programming menu, SEtPtS. Program the alarm set/reset and preset values. To exit main programming menu and return to reading press the ACK button.</p>	

Programming Alarm Points and Presets (**SEtPt5**)

Overview

The **SEtPt5** menu is used to program the following functions:

1. Set and reset points for alarms assigned to process/rate (thus determining High or Low alarm status and deadband.)
2. Preset values for set points assigned to total
3. Preset offset values for set points assigned to total with **OFFSEt** selected

Set and Reset Points for Process/Rate Alarms

The meter can be programmed so any alarm point that is assigned to process/rate can be set for a high or low alarm. In addition, any process/rate alarm point can be programmed for 0-100% deadband. A process/rate alarm is programmed for a High alarm, by programming the set point at a higher value than the reset point. Conversely, a process/rate alarm is programmed for a low alarm, by programming the set point at a lower value than the reset point.

Example: To program an alarm for a high alarm at 500, with 100 counts of deadband program set and reset points as follows:

Set point:	500
Reset point:	400

Preset Values for Total Set Points

When a set point is assigned to total, a preset value at which the relay will trip must be programmed. Unlike set points assigned to process/rate, which require a set and reset point, set points assigned to total require only a preset value. When the preset value is reached, the relay transfers. The relay can be programmed to reset automatically or manually.

Preset Offset Values for Total Set Points (**OFFSEt**)

A preset offset value can be assigned when two adjacent set points are assigned to total and the second one has been assigned to **OFFSEt** during **SEtPt5** above. The first relay of a pair will trip at a programmed preset offset value below the second relay's preset value.

Example: If the preset offset value is set at 10 then the first relay will trip at 10 counts before the second relay trips.

In the above example the relay pair combination could be 1 & 2, 2 & 3, or 3 & 4.

Programming Alarm and Preset Values (SEtPt5)

Alarm, preset, and preset offset values are programmed under the **SEtPt5** menu, one at a time, starting with set point 1. The set points are programmed according to whether they were assigned to process/rate or total during the **SEtPtP** program. For set points assigned to process/rate it is necessary to program both a set and reset point. For set points assigned to total, either a preset value or preset offset value needs to be programmed.

The 4 discrete LEDs to the left of the display indicate which set point is being programmed.

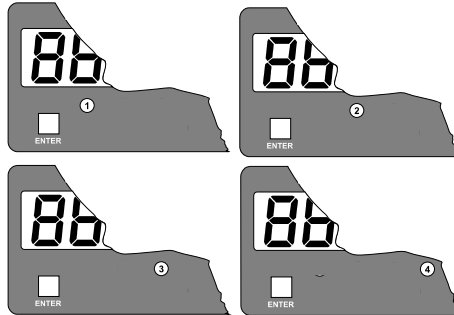

Figure 18. Display Showing Location of Set Point LEDs

For set points assigned to process/rate, there are also two LEDs below the display labeled **S** and **R** that indicate whether a set or reset point is being programmed.

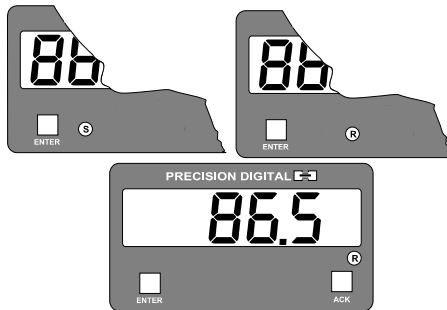

Figure 19. Display Showing Location of Set, Reset, and Rate LEDs

When programming set points assigned to total, only one of the 4 discrete LEDs below the display will be illuminated at a time. A flashing LED indicates that a preset offset value is being programmed, a steady-on LED indicates that a preset value is being programmed.

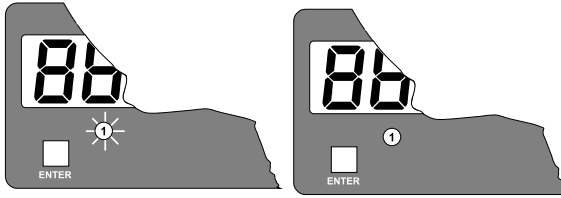

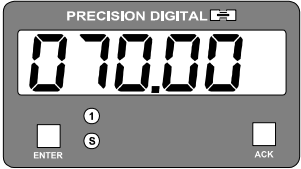
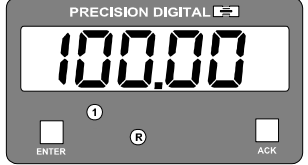



Figure 20. Programming Status of Set Point LEDs Assigned to Total

<p>Note To simplify programming, write down the desired programming values prior to attempting to program the meter. The Programmed Parameter Settings form located at the back of this manual provides a convenient method to record the user settings; it also provides the factory setting for most of the programmable parameters.</p>	
<p>Press ENTER, then press ENTER again when the set points (SEtPt5) function appears. The display will scroll through the set points, press ENTER when the desired set point is displayed to program that set point.</p>	 <div style="border: 1px solid black; padding: 2px; display: inline-block; margin-top: 5px;">SEtPt5</div>
<p style="text-align: center;">To program set points values</p> <p>Set point 1 (SEt 1) will be displayed. Press ENTER to program set point 1 or wait and the display will move to the next set point. When set point 4 (SEt 4) is shown, the meter will exit the set points (SEtPt5) menu and move to the next programming function.</p> <p>The output function is displayed if the meter is equipped with a 4-20 mA output option.</p>	<div style="border: 1px solid black; padding: 2px; display: inline-block; margin-bottom: 5px;">SEt 1</div> <p style="text-align: center;">then</p> <div style="border: 1px solid black; padding: 2px; display: inline-block; margin-bottom: 5px;">SEt 2</div> <p style="text-align: center;">then</p> <div style="border: 1px solid black; padding: 2px; display: inline-block; margin-bottom: 5px;">SEt 3</div> <p style="text-align: center;">then</p> <div style="border: 1px solid black; padding: 2px; display: inline-block; margin-bottom: 5px;">SEt 4</div> <p style="text-align: center;">then</p> <div style="border: 1px solid black; padding: 2px; display: inline-block; margin-bottom: 5px;">outPut</div>
<p>If ENTER is pressed while set point 1 (SEt 1) is shown, the display will then show a flashing number. Follow instructions below to program set points assigned to process/rate and set points (presets) assigned to total.</p>	 <div style="border: 1px solid black; padding: 2px; display: inline-block; margin-top: 5px;">SEt 1</div> <p style="text-align: center;">then</p> <div style="border: 1px solid black; padding: 2px; display: inline-block; margin-bottom: 5px;">070.00</div>
<p style="text-align: center;">Set points assigned to process/rate</p> <p>For set points that have been assigned to process/rate during the SEtPt function, the alarm # (1,2,3, or 4) and the S (set point) LED will be illuminated. This indicates that the set point for alarm # (1, 2, 3, or 4) is being programmed.</p>	 <p style="text-align: center;">Meter displaying alarm # 1 set point</p>

<p>Set the display for alarm # (1,2,3 or 4) set point</p> <p>The entire display will flash for three seconds. For instructions see <i>Five Basic Digit/Display Setting Instructions</i>, page 30.</p>	<div style="border: 1px solid black; padding: 2px; text-align: center;">070.00</div> <p style="text-align: center;">then</p> <div style="border: 1px solid black; padding: 2px; text-align: center;">170.00</div> <p style="text-align: center;">then</p> <div style="border: 1px solid black; padding: 2px; text-align: center;">120.00</div> <p style="text-align: center;">final</p> <div style="border: 1px solid black; padding: 2px; text-align: center;">125.00</div>
--------------------------------------------------------------------------------------------------------------------------------------------------------------------------------------------------------------	------------------------------------------------------------------------------------------------------------------------------------------------------------------------------------------------------------------------------------------------------------------------------------------------------------------------------------------------------------------------------------------------------------------------------------------------------------------------------

<p>Set the display for alarm # (1,2,3, or 4) reset point</p> <p>As soon as the set point for alarm # (1,2,3 or 4) has been programmed, the meter displays the reset point for alarm # (1,2,3, or 4). This is indicated by the alarm # (1, 2, 3, or 4) LED and R (reset point) LED being illuminated. The reset point is programmed in the same fashion as the set point above.</p>	 <p style="text-align: center;">Meter displaying alarm # 1 reset point</p>
--------------------------------------------------------------------------------------------------------------------------------------------------------------------------------------------------------------------------------------------------------------------------------------------------------------------------------------------------------------------------------------------------	-------------------------------------------------------------------------------------------------------------------------------------------------------------

<p>Press ENTER, then press ENTER again when the set points (SEtPt5) function appears.</p>	<div style="display: flex; align-items: center;"> <div style="border: 1px solid black; padding: 2px; margin-right: 10px;">ENTER</div> <div style="border: 1px solid black; padding: 2px; margin-right: 10px;">SEtPt5</div> </div> 
----------------------------------------------------------------------------------------------------------------	---------------------------------------------------------------------------------------------------------------------------------------------------------------------------------------------------------------------------------------------------------------------------------------------------------------------

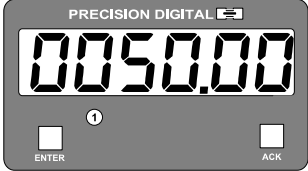
<p>Preset values for set points assigned to total without offset</p> <p>For set points that have been assigned to total without offset during the SEtPt function, the preset # (1,2,3, or 4) will be illuminated. This indicates that the value for preset # (1, 2, 3, or 4) is being programmed.</p>	 <p style="text-align: center;">Meter displaying preset # 1</p>
---------------------------------------------------------------------------------------------------------------------------------------------------------------------------------------------------------------------------------------------------------------------------------------------------------------------	---------------------------------------------------------------------------------------------------------------------------------------------------

<p>Set the display for preset # (1,2,3, or 4)</p> <p>The entire display will flash for three seconds. For instructions see <i>Five Basic Digit/Display Setting Instructions</i>, page 30.</p>	<div style="border: 1px solid black; padding: 2px; text-align: center;">070.00</div> <p style="text-align: center;">then</p> <div style="border: 1px solid black; padding: 2px; text-align: center;">170.00</div> <p style="text-align: center;">then</p> <div style="border: 1px solid black; padding: 2px; text-align: center;">120.00</div> <p style="text-align: center;">final</p> <div style="border: 1px solid black; padding: 2px; text-align: center;">125.00</div>
------------------------------------------------------------------------------------------------------------------------------------------------------------------------------------------------------	------------------------------------------------------------------------------------------------------------------------------------------------------------------------------------------------------------------------------------------------------------------------------------------------------------------------------------------------------------------------------------------------------------------------------------------------------------------------------

Press **ENTER**, then press **ENTER** again when the set points (**SEtPtS**) function appears.

ENTER



SEtPtS

Preset values for set points assigned to total with offset

If a set point was assigned to total with offset during the **SEtPtS** function, it means that this set point and the one before it function as a pair. That is, the first relay will always trip a specified number of counts before the second relay. This is called the preset offset value and it is programmed as the first “preset” in a pair of set points setup for offset. The second value in a pair of set points setup for offset represents the actual preset value.



Meter displaying preset offset between set points 1 and 2

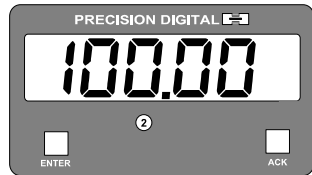

Meter displaying preset for set point 2

Preset value (# LED on left is steady-on)

Set the display for preset offset and preset values

The entire display will flash for three seconds. For instructions see **Five Basic Digit/Display Setting Instructions**, page 30.

070.00

then

170.00

then





120.00

final

125.00

4-20 mA Isolated Output Option Programming (*outPut*)

Programming the 4-20 mA transmitter output option for the meter does not require the use of a calibrator. The transmitter output can be calibrated so that a 4 mA output is produced for any process/rate measured by the meter. The 20 mA output may correspond to any process/rate that is at least 501 counts greater or smaller than the process/rate corresponding to 4 mA. (Ex. 4 mA = 0, 20 mA = 501). If the span between 4 and 20 mA is less than 501 counts, an **Error** message will appear and the previously programmed values will be retained in memory until a new set of values is accepted.

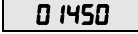
<p>Press ENTER, then press ENTER again when the Output menu appears.</p>		
<p>Set the display for value at which 4 mA is produced The green LED labeled “4” will be on indicating the meter is ready to accept the value at which 4 mA is produced. The entire display will flash for three seconds. For instructions see Five Basic Digit/Display Setting Instructions, page 30.</p>	 final 	
<p>Set the display for value at which 20 mA is produced The green LED labeled “20” will now be on indicating the meter is ready to accept the value at which 20 mA is produced. Program this value in the same fashion as was done above.</p>	 final 	

4-20 mA Output Programming Confirmation

The values that have been programmed to produce the 4 & 20 mA outputs can be quickly checked to make sure they are the desired values. To do this, access the output (*outPut*) routine by pressing **ENTER**, and then pressing **ENTER** again when *outPut* appears.

The green “4” LED illuminates indicating the meter is displaying the value at which it will produce a 4 mA output. Confirm that this is the desired value. Press **ENTER** (within 3 seconds) before the entire display stops flashing and the green “20” LED illuminates indicating the meter is displaying the value at which it will produce a 20 mA output. Confirm that this is the desired value. Press **ENTER** (within 3 seconds), before the entire display stops flashing and the meter returns to indication mode.

Lockout and Display Selection Programming

Overview

The meter provides the user with the ability to restrict modification of programming values and to exclude menu titles from appearing during the menu scroll. Restricting modification of the programming values is accomplished by installing the lockout jumper (JP1). Excluding menu titles from the menu scroll is performed with the display (**dSPRAY**) menu.

Lockout

The Lockout jumper is used to restrict modification of calibration and programming values. It is labeled JP1 "LOCK", and it is located at the top middle of the Main Board. Access JP1 by removing the Display Board. When **ENTER** is pressed with the lockout jumper in place, **SCALE**, **CAL Ib**, **CutOFF**, **tBASE**, **tCF**, and **tDP** do not appear during the menu scroll, and thus can not be modified.

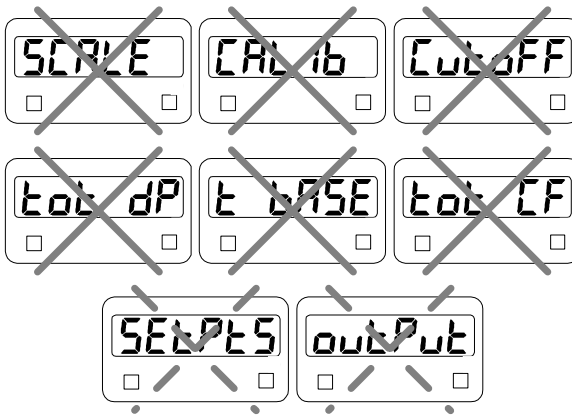

SEtPt5 menu title always appears. Ability to change values may be restricted.

outPut menu title appears only if 4-20 mA output option is installed.

Figure 21. Functions Locked Out with the Lockout Jumper

Notes:

1. The other function the lockout jumper performs is activating selections made through the display (**dSPRAY**) menu. That is, selections made through the display menu only become active when the lockout jumper is installed.
2. With the lockout jumper in place, the set points (**SEtPt5**) menu still appears. To program the meter so the set, reset, or preset points can only be viewed and not changed, it is necessary to set the **SEtPt5** menu to no (**n**) in the display (**dSPRAY**) menu. To be able to change these values, set the **SEtPt5** menu to yes (**y**).

Display Selection (*dSPLY*)

The *dSPLY* menu is used to remove menu titles from appearing during the menu scroll. This feature is useful for eliminating unused menu titles from the menu scroll; making it impossible to perform certain functions, and making the display automatically toggle between process/rate and total.

For instance, the user may want to eliminate certain unused menu titles from the scroll that do not relate to a particular application such as those relating to flow totalization. The display (*dSPLY*) menu could be used to eliminate the reset total (*rSEt t*) and the display total (*dSPLY t*), and thus streamline the menu.

A supervisor may want to make it impossible for an operator to perform certain functions, but still allow himself to perform them without having to remember passwords or remove a hard-to-get-at jumper. For instance, a supervisor could program the meter with the batch presets he wants and disable the *SEtPtS* menu (thus making it impossible for a user to change the batch presets) by using the *dSPLY* menu. When the supervisor wants to change the batch presets, he can reactivate the *SEtPtS* menu and make his changes. Or a supervisor may want to make it impossible for an operator to reset the total via the front panel, but still allow himself to do it easily. This can be accomplished by removing the *rSEt t* (reset total) menu title from the menu scroll, thus making it impossible to reset the total via the front panel and then reactivating it when he wants to reset the total.

Finally the user may want to make the display automatically toggle between rate and total. This can be accomplished by setting both display rate (*dSPLY r*) and display total (*dSPLY t*) menus to no (*n*), as described below.

With the lockout jumper in place, the menu titles of display rate, display total, reset total, display peak, set points, display, and output can still be accessed.

The 4-20 mA output calibration points can be viewed, but can not be modified.

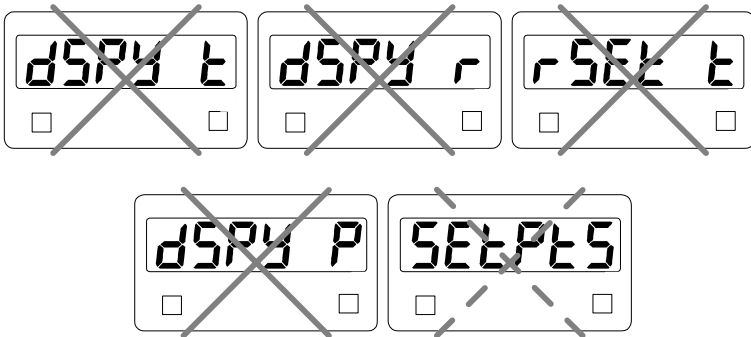

SEtPtS menu title always appears. Ability to change values may be restricted.

Figure 22. Menu Titles Excluded with Display Menu

Notes:

1. User may program which of these routine titles are active during operation and which ones are not. See below for instructions.
2. **Note:** Selections made through the display menu (dSPRAY) can be made with or without the lockout jumper installed, but only become active when the lockout jumper is installed.
3. With the lockout jumper in place, the **SEtPtS** menu still appears.
4. Selecting **y** for **SEtPtS** will allow an operator to view and change set/reset points and presets even with the lockout jumper in place.
5. Selecting **n** for **SEtPtS** will still allow an operator to view set/reset points and presets, but not to make changes.
6. Select **n** for both **dSPY r** and **dSPY t** to program display to toggle between rate and total every 10 seconds.
7. Total can be reset with an external push-button even if **rSEt t** is set to **n**.

Alternating Display

Display may be programmed to toggle between rate and total every 10 seconds. The alternating display feature is programmed, by selecting **n** for both **dSPY r** and **dSPY t**, under Display Selection menu (**dSPRAY**).

Note: Selections made through the display menu (dSPRAY) can be made with or without the lockout jumper installed, but only become active when the lockout jumper is installed.

The Lockout jumper must be installed to see alternating display or any other display selection made.

Include or Exclude Menu Titles From Menu Scroll

<p>Press ENTER, then press ENTER again when the display (dSPRAY) function appears. The meter will now scroll through the various menu titles that can be included or excluded. To program a menu title, press ENTER when it appears.</p>		
<p>Set menu scroll to include/exclude display rate Display process/rate (dSPY r) will appear for 3 seconds. Press ENTER to set. Otherwise wait and meter moves on to next menu title.</p>		
<p>Yes or no (y or n) will flash alternately. To include this function in menu scroll, press ENTER when y is displayed. To exclude it, press ENTER when n is displayed.</p>		
<p>Set menu scroll to include/exclude display total Display total (dSPY t) will appear for 3 seconds. Press ENTER to set. Otherwise wait and meter moves on to next menu title.</p>		
<p>Yes or no (Y or N) will flash alternately. To include this function in menu scroll, press ENTER when y is displayed. To exclude it, press ENTER when n is displayed.</p>		
<p>Set menu scroll to include/exclude reset total Reset total (rSEt t) will appear for 3 seconds. Press ENTER to set. Otherwise wait and meter moves on to next menu title.</p>		
<p>Yes or no (Y or N) will flash alternately. To include this function in menu scroll, press ENTER when y is displayed. To exclude it, press ENTER when n is displayed.</p>		
<p>Set menu to include/exclude display peak Display peak (dSPY P) will appear for 3 seconds. Press ENTER to set it. Otherwise wait and meter moves on to next menu title.</p>		
<p>Yes or no (Y or N) will flash alternately. To include this function in menu scroll, press ENTER when y is displayed. To exclude it, press ENTER when n is displayed.</p>		
<p>Set menu scroll to include/exclude set points Set points (SEtPtS) will appear for 3 seconds. Press ENTER to set. Otherwise wait and meter moves on to next menu title.</p>		
<p>Yes or no (Y or N) will flash alternately. To include this function in menu scroll, press ENTER when y is displayed. To exclude it, press ENTER when n is displayed.</p>		

OPERATION

Overview

This instrument is an analog input process meter with flow rate, totalizer, and batch control capabilities. It accepts the common process signals such as 4-20 mA, 0-5 VDC, 1-5 VDC, and 0-10 VDC. It displays these signals in any engineering unit on a 1.0" high, 4½ digit LED display for process/rate and six full digits for total. The meter also provides two isolated 24 VDC power supplies to drive both the input and output loops. Options include up to 4 relays for alarms or batch control applications as well as an isolated 4-20 mA transmitter output.

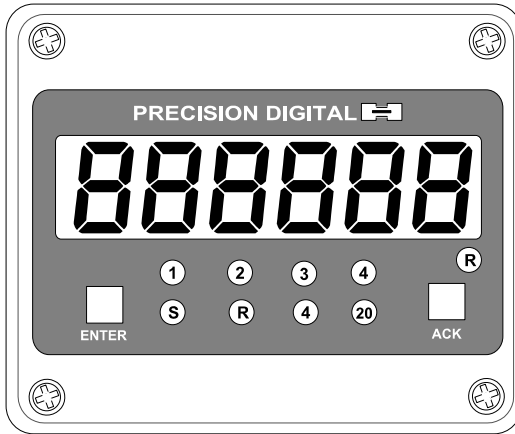

Figure 23. Front Panel LEDs

The front panel of the meter consists of six 1.0" high seven-segment LEDs as well as nine programming/operational LEDs. The programming/operational LEDs provide the following indication:

LED	During Programming	During Operation
1	Alarm 1	Alarm 1
2	Alarm 2	Alarm 2
3	Alarm 3	Alarm 3
4	Alarm 4	Alarm 4
S	Set point indicator	None
R	Reset point indicator	None
4	4 mA output indicator	None
20	20 mA output indicator	None
R	Rate indicator	Rate

The four alarm status LEDs indicate alarm condition only and do not represent relay status when set points are set up for non-latching relay mode. For instance, if alarm 1 is programmed for a high alarm at 500 with manual reset of the relays and the operator resets the relays when the display reads 650, the #1 LED will stay on until the display falls below 500.

Set points setup for latching relay mode will reflect the status of the LEDs, regardless of the status of the alarm condition. For instance, when a latching relay is acknowledged the corresponding status LED will extinguish.

Two Types of Display: Process/Rate and Total

The meter also has the capability to display flow total by integrating the flow rate input. The operator may toggle back and forth between flow rate and total automatically or manually. When the meter is displaying rate, an LED labeled **R** on the right side of the front panel, illuminates to indicate this. There is no loss of data while performing any of the programming or calibration operations; the meter continues working in the background even when values are being reprogrammed.

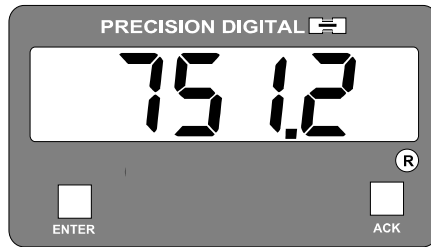

Figure 24. Meter Displaying Process/Rate



Figure 25. Meter Displaying Total

Basic Meter Operation

Overview

In its most basic form, the meter provides a digital display in engineering units of any process variable from a transmitter, such as temperature, pressure, level, flow, etc. The meter is calibrated for the appropriate range, the output of the transmitter is connected to the meter and the meter displays the process. As a standard feature, the meter can also provide the power to drive the input transmitter and the 4-20 mA output option while maintaining isolation between the input and the output signals.

ENTER and ACK Button Operation

In addition to programming the meter, the **ENTER** button is also used to operate the meter. The **ENTER** and **ACK** buttons are located behind the front panel and are accessible with the cover installed. The functions of the **ENTER** and **ACK** buttons are brought out to screw terminals to provide remote access to these functions.

The **ACK** button is used to acknowledge the relays during operation and to quit main menu scroll during programming, diagnostic menu, and calibration.



The **ENTER** button performs the following operations with lockout jumper installed:

Function Displayed		Definition
dSPY r	Display process/rate	Sets the process/rate as the default display
dSPY t	Display total	Sets the total as the default display
rSEt t	Reset total	Resets the totalizer to zero.
dSPY P	Display peak	Displays the highest process/rate value captured
rSEt P	Reset peak	Erases peak value from memory and captures a new reading
dSPLAY	Display selection	Activates or de-activate display functions
d IAS	Diagnostic	Displays parameter settings one at a time for diagnostic purposes.



Display Peak & Reset Peak Operation (dSPY P & rSEt P)

The meter captures the highest process/rate reading and displays it through the display peak (dSPY P) menu function. The peak value may be reset using the reset peak (rSEt P) menu function.

Display Peak (Hold) Reading

<p>Press ENTER, then press ENTER again when the display peak (dSPY P) menu-title appears.</p>		
<p>Meter displays peak reading The meter is now displaying the peak reading as indicated by the flashing green "R" LED on the right side.</p>		

Reset Peak Reading

<p>Press ENTER, then press ENTER again when the reset peak (rSEt P) menu-title appears.</p>		
<p>Meter returns to displaying current value The meter is now displaying the current value. The flashing green "R" LED on the right side has stopped flashing.</p>		

Note:

While in the display peak (dSPY P) mode, the meter continues capturing new peaks; but it does not respond to signals below the last peak value captured; it remains "locked" on the peak display reading. For instance, if while the meter is displaying a peak of 100, the input increases to 150, the new peak of 150 will be displayed. If the input falls down to 125 before the peak display is reset, the meter will continue displaying 150 as the peak reading.









Rate Meter Operation

Overview

The meter can also be used to display flow rate and is available with a low-flow cutoff feature. Totalizer functions can be excluded from the menu scroll through the **dSPY** menu function, if the user is not interested in total display.

Display Rate (**dSPY r**)

The user may toggle between a display of process/rate or total at any time. When displaying process/rate, the process/rate LED indicator will be illuminated. To change the display to rate:

<p>To change the display from reading total to rate</p> <p>Press ENTER to begin scrolling through the functions.</p>	 <p>PRECISION DIGITAL </p> <p>346253</p> <p>ENTER ACK</p>
<p>When display rate (dSPY r) appears, press ENTER.</p>	  <p>PRECISION DIGITAL </p> <p>dSPY r</p> <p>ENTER ACK</p>
<p>The meter now displays rate and the green "R" LED on the right side is illuminated.</p>	 <p>PRECISION DIGITAL </p> <p>4.56 </p> <p>ENTER ACK</p>

Low-Flow Cutoff (**CuTtOFF**)

The low-flow cutoff feature allows the meter to be programmed so that the often-unsteady output from a differential pressure transmitter at low-flow rates always displays zero on the meter. For instance, if the low-flow cutoff is set at 50, any flow rate below 50 will result in a display of zero on the meter.

The totalizer in the meter accumulates based on the rate display. This means that when the rate display is zero, even as a result of the low-flow cutoff, the totalizer will not accumulate.





Totalizer Operation

Overview

The meter provides a display of accumulated flow total by integrating the flow rate input to the meter and multiplying this value by a user-defined totalizer conversion factor. The total is displayed on a six-digit display that is capable of reading to 999,999. When the total exceeds 999,999, the display “rolls” over and begins counting from zero again without losing counts. The total can be reset at any time via the front panel, via an external switch closure, or when the meter reaches the highest preset value.

Display Total (dSPY t)

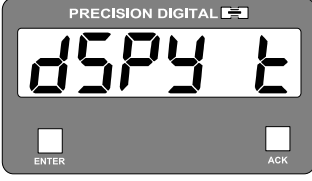
The user may toggle between a display of process/rate or total at any time. When displaying process/rate, the process/rate LED indicator will be illuminated.

<p>To change the display from reading “rate” to “total”</p> <p>The meter is now displaying rate, as indicated by the green “R” LED illuminated on the right side of the display. Press ENTER to begin scrolling through the functions.</p>		
<p>When display total (dSPY t) appears, press ENTER.</p>		
<p>The meter now displays total.</p>		

Total Conversion Factor (tot CF) & Time Base (t bASE)

The total conversion factor is a number that is multiplied by the rate to compute the total. Time bases are available in second, minute, hour, and day.

Applications Using Total Conversion Factor and Time Base

The following tables illustrate the effect various total conversion factors and time bases have on the operation of the meter:

Application #1

Rate	Time base	Total conv factor	Total after one second	Total after one minute	Total after one hour	Total after one day
60 GPM	Min	1	1 gallon	60 gallons	360 gallons	8640 gallons

In the above application, a totalizer conversion factor of 1 with a rate of 60 GPM results in a total of 60 gallons after 1 minute.

Application #2

Rate	Time base	Total conv factor	Total after one second	Total after one minute	Total after one hour	Total after one day
60 GPM	Min	0.2	0.2 can	12 cans	720 cans	17280 cans

In the above application, 5-gallon paint cans are being filled and the user wants to keep track of the number of cans that have been filled, not the total gallons of paint that has been dispensed.

Application #3

Rate	Time base	Total conv factor	Total after one second	Total after one minute	Total after one hour	Total after one day
10 MGD	Day	1	0.0001	0.0069	0.4166	10.0000 Million gls

In the above application, a wastewater treatment plant has an effluent of 10 million gallons per day. A totalizer conversion factor of 1 and a time base of day, results in a total display of 10.0000 million gallons after one day.

Totalizer Reset

The totalizer may be reset in any of three ways:

1. Via the front panel **ENTER** button
2. External contact closure
3. Automatically via highest preset value

Resetting Total Using the ENTER Button

<p>Press ENTER, then press ENTER again when the reset total (rSEt t) function appears. After ENTER is pressed, the total display resets to zero.</p>		<p>87652.0</p> <p>then</p> <p>rSEt t</p> <p>then</p> <p>0.0</p>
----------------------------------------------------------------------------------------------------------------------------------------------------------------------------------	-----------------------------------------------------------------------------------	--------------------------------------------------------------------------------------

Note: It is possible to exclude the reset total (**rSEt t**) function from the menu scroll. See Display Selection (dSPly), page 61 for details.

Resetting Total via External Contact Closure

The total may be reset at any time by closing a normally open push-button switch that is wired across terminals R and CM located on connector J1 of the Main Board. See Figure 11 on page 26 for details. Note that this switch is still functional even if the reset total (**rSEt t**) function has been removed from the menu scroll.

Resetting Total Automatically via User Selectable Preset

The meter can also be programmed so the total automatically resets when the total reaches a user selectable preset value. This will be discussed in more detail in **Automatic Batch Control Operation** section, page 79.

Relays Operation

Overview

The Relays capabilities of the meter expand its usefulness beyond simple indication to provide users with alarm and control functions. These capabilities include front panel alarm status LEDs as well as either 2 or 4 optional relays. Typical applications include high or low temperature, level, pressure or flow alarms, simple control applications like sump-pump or tank-filling and automatic or manual batch controlling. There are four basic ways the relays can be used:

1. High or Low Alarms
2. Simple On/Off Control with 100% Adjustable Deadband
3. Automatic Batch Control
4. Manual Batch Control

Relays Auto Initialization

When power is applied to the meter, the front panel LEDs and alarm relays will reflect the state of the input to the meter. For instance, if the meter is powered up and reads 500, the following table indicates how the alarm LEDs and relays will react based on the various set and reset points:

Alarm #	HI or LO	Set Point	Reset Point	Power-up Reading	Relay & LED
1	HI	1000	500	499	Off
2	LO	700	900	500	On
3	LO	250	400	500	Off
4	HI	450	200	500	On

Fail-Safe Operation

The following table indicates how the relays behave based on Jumper J5 being installed or not installed:

Jumper J5 on Options Board	Fail-Safe	Relay Coils Energized in	Power Failure
On	Enabled	Non-alarm state	Relays go to alarm state
Off	Disabled	Alarm state	Relays go to non-alarm state

Front Panel LEDs

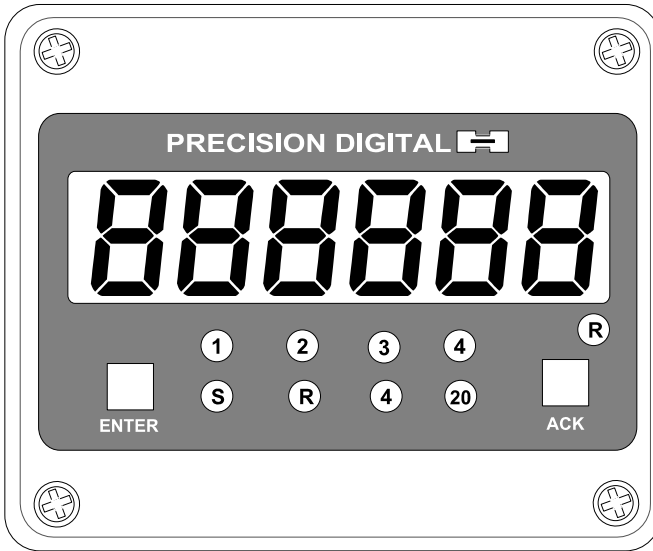

Figure 26. Front Panel LED Indicator Locations

The LEDs on the front panel provide status for the following:

LED	Status
1	Alarm 1
2	Alarm 2
3	Alarm 3
4	Alarm 4

LED	Status
S	Set Point Indicator
R	Reset Point Indicator
4	4 mA indicator
20	20 mA indicator
R	Rate indicator

The meter is supplied with four alarm points that include front panel LEDs to indicate alarm conditions. This standard feature is particularly useful for alarm applications that require visual-only indication. The front panel LEDs are controlled by the set and reset points programmed by the user. When the display passes a set point for a particular alarm, that alarm’s LED will light up. When the meter passes back through that alarm’s reset point the LED will go off. The front panel LEDs respond differently for latching and non-latching relays.

For non-latching relays, the LED is always off during normal condition and always on during alarm condition, regardless of the state of the relay.

For latching relays, the alarm LEDs reflect the status of the relays, regardless of the alarm condition. The following tables illustrate how the alarm LEDs function in relation to the relays and the acknowledge button:

Relay key legend for following tables

Key	Relay condition
On	Tripped
Off	Reset
Ack	Acknowledged

The On and Off keys do not refer to the status of the relay's coil, which depends on the fail-safe mode selected.

Non-Latching Relay**Automatic reset only JP5(1-4 off)**

Condition	LED	Relay
Normal	Off	Off
Alarm	On	On
Ack (No effect)	On	On
Normal	Off	Off

In this application, the meter is set up for automatic reset and non-latching relay. Acknowledging the alarm while it is still present has no effect on either the LED or the relay. When the alarm finally goes away, the relay automatically resets and the LED also goes Off.

Non-Latching Relay**Automatic + manual reset at any time JP5(1-4 on)**

Condition	LED	Relay
Normal	Off	Off
Alarm	On	On
Normal	Off	Off

In this application, the meter is set up for automatic + manual reset at any time and non-latching relay. The LED and the relay automatically reset when the meter returned to the normal condition.

Automatic + manual reset at any time JP5(1-4 on)

Condition	LED	Relay
Normal	Off	Off
Alarm	On	On
Ack	On	Off
Normal	Off	Off

In this application, the meter is also set up for automatic + manual reset at any time. But this time, an operator acknowledges the alarm manually while it still exists. This causes the relay to reset, but the LED stays On until the meter returns to the normal condition. (Remember, for non-latching relays, the LED is always Off during normal condition and always On during alarm condition, regardless of the state of the relay).

Latching Relay**Manual reset only after signal passes reset point JP5(1-4 off)**

Condition	LED	Relay
Normal	Off	Off
Alarm	On	On
Ack (No effect)	On	On
Normal	On	On
Ack	Off	Off

In this application, the meter is set up for manual reset only after the signal passes the reset point of the latching relay. Acknowledging the alarm while it is still present has no effect on either the LED or the relay. When the alarm is acknowledged after it returns to the normal state, the LED and the relay go Off. Notice that the LED remained On, even after the meter returned to the normal condition. This is because, for latching relays, the alarm LEDs reflect the status of the relays, regardless of the alarm condition.

Manual reset only after signal passes reset point JP5(1-4 off)

Condition	LED	Relay
Normal	Off	Off
Alarm	On	On
Normal	On	On
Ack	Off	Off

In this application, the meter is set up for manual reset only after the signal passes the reset point of the latching relay. When the alarm is acknowledged after it returns to the normal state, the LED and the relay go Off.

Latching Relay**Manual reset any time JP5(1-4 on)**

Condition	LED	Relay
Normal	Off	Off
Alarm	On	On
Ack	Off	Off

In this application, the meter is set up for manual reset at any time. Acknowledging the alarm even if the alarm condition is still present resets the relay and turns off the LED.

Acknowledging Relays

There are two ways to acknowledge relays programmed for manual reset: via the front panel ACK button and remotely via a switch wired across AK and CM terminals on the Main Board. When the ACK button or a switch wired across the AK and CM terminals is closed, all relays programmed for manual reset will reset.

The "total" display is not affected by this action and therefore pressing the ACK button or closing the ACK switch will not reset the total.

Simple On/Off Control with 100% Deadband Operation

The meter can be used as a simple On/Off controller as the following illustrates:

Using the meter for sump-pump control and alarm control

Relay #1 turns the main pump on at 6000 gallons and turns it off at 1000 gallons.

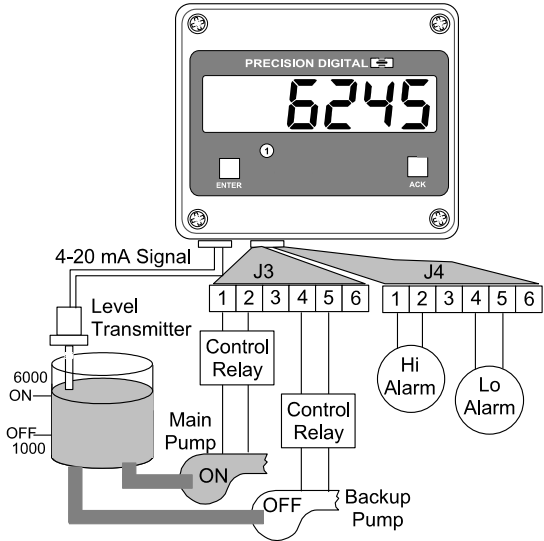

Relay #2 turns on the backup pump at 7000 gallons and turns it off at 1000 gallons.

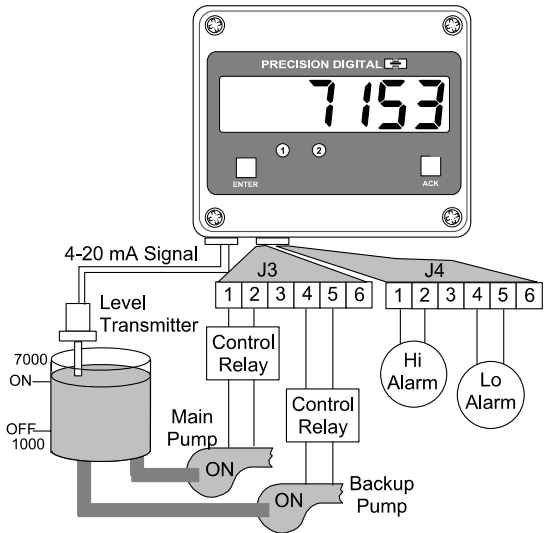

Relay #3 trips the High Level Alarm at 7500 gallons and resets at 6900 gallons.

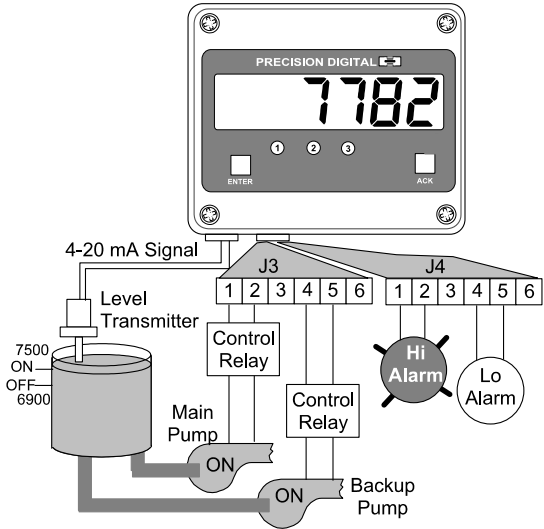



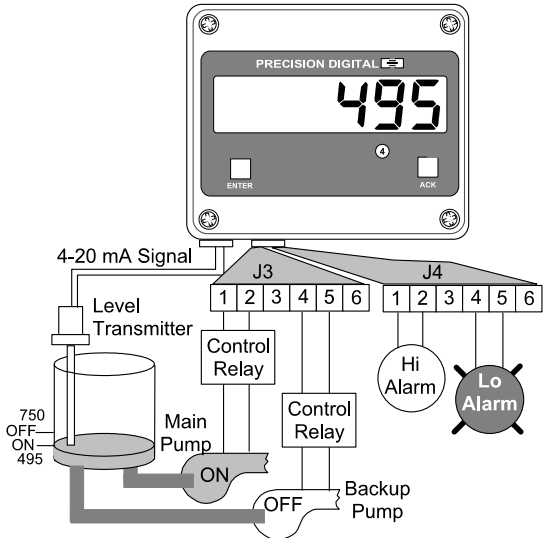

Relay #4 trips the Low Level Alarm at 495 gallons and it resets at 750 gallons.







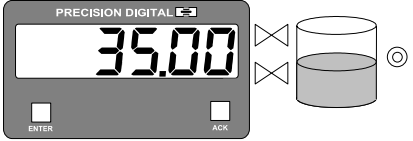
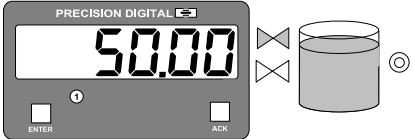
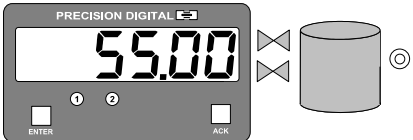
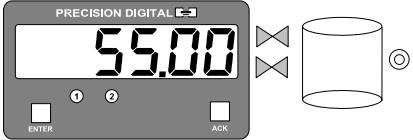
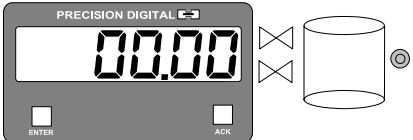
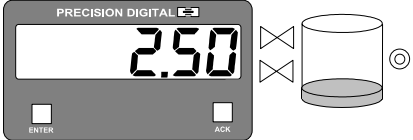

Manual Batch Control Operation

The meter can be used for simple manual batch control as the following illustrates:

<p>The valve and External Switch KEY Legend is as shown:</p>	<div style="border: 1px solid black; padding: 5px;"> <p style="text-align: center;">KEY</p> <p> = VALVE CLOSED</p> <p> = VALVE OPEN</p> <p> = External RESET Switch</p> <p> = External RESET Switch Pressed</p> </div>
<p>Both valves are open to fill the barrel: Meter displays barrel contents.</p>	
<p>Full-flow valve #1 is closed and restricted-flow valve #2 "dribbles" in the remaining 5 gallons.</p>	
<p>When total reaches 55.00, relay 2 trips and closes restricted-flow valve #2. Display freezes on 55.00 and relays 1 and 2 will not reset until external switch is pushed.</p>	
<p>Both valves are still closed and a new barrel is positioned. Meter displays previous barrel's contents until external reset button is pushed.</p>	
<p>Operator presses reset switch to reset total. Total goes to zero. Both relays reset causing both valves to open and begin filling the new barrel.</p>	
<p>Both valves are open to fill the barrel: Meter displays barrel contents.</p>	

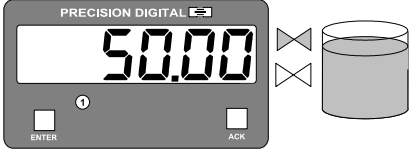
Automatic Batch Control Operation

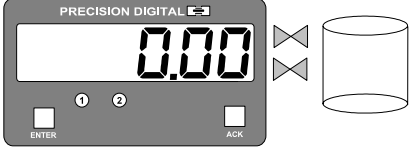
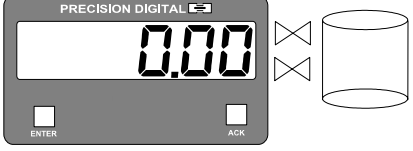
The meter can be used for automatic batch control as the following illustrates:

<p>The valve KEY Legend is as shown:</p>	<div style="border: 1px solid black; padding: 5px;"> <p style="text-align: center;">KEY</p> <p> = VALVE CLOSED</p> <p> = VALVE OPEN</p> </div>
<p>Both valves are opened to fill the barrel. The top valve is the full flow valve, the bottom valve the restricted flow valve. The meter displays the barrel's content.</p>	
<p>Full-flow valve #1 is closed and restricted-flow valve #2 "dribbles" in the remaining 5 gallons.</p>	
<p>When the total reaches 55.00 gallons, relay 2 trips and the restricted valve #2 closes. This automatically causes the total to reset to zero.</p>	
<p>The full tank is removed and a new tank inserted. The valves are still closed; the two relays are still in the tripped condition.</p>	
<p>After the programmed delay has elapsed, the two relays will reset and the two valves will open.</p>	
<p>The tank will now begin to fill.</p>	

Delay on Release (dELAY)

The meter can be programmed so that when the highest preset value is reached the total will automatically reset to zero (Automatic Batch Control). A delay on release can be programmed to reset the total relays after the delay has elapsed. The delay can be programmed from 1 to 999 seconds.

Example: Under the **SEtUP** menu, relay 1 and 2 are assigned to total, **OFFSEt** is not selected, internal total reset (**I**) is selected and a **dELAY** of 60 second is programmed. Under **SEtPtS** menu, the preset values are programmed as follows:

SEt I (preset 1): 1000

SEt 2 (preset 2): 2000

When the total reaches 1000, relay 1 transfers. The total keeps increasing until it reaches 2000; at that moment, relay 2 transfers, the total resets to zero automatically, delay on released starts. Then 60 seconds later relays 1 and 2 reset automatically and are ready to start a new batch.

Priority Batch Programming or Quick Presets

For some batch control applications it may be necessary to change the presets frequently. The meter has a quick preset change feature that allows all presets to be changed without entering the programming routine.

To change presets without entering the programming routine press and hold the **ENTER** button for 3 seconds. The meter will go immediately to the first preset; the user can now program all presets. After the last preset has been programmed the meter returns to reading the process/rate or total.

Batch Control with Varying Batch Sizes

To simplify batch control applications with varying batch sizes, use one or more switches to control the relay outputs. The switch allows the operator to disable the process when changing presets in the meter and then enable the process after all the changes have been made and the process is ready to resume. The switch serves as a "Stop/Ready" control.

See application note AN-0001 at www.predig.com.

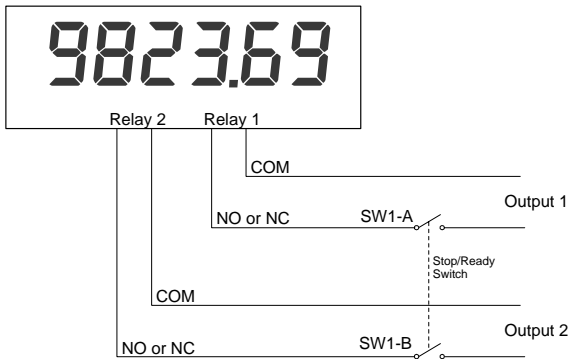

Pump Alternation Control

For pump control applications where two similar pumps are used to control the level of a tank or a well, it is desirable to have the two pumps operate alternately. This prevents excessive wear and overheating of one pump over the lack of use of the second pump.

A pair of relays can be set up to alternate every time an on/off pump cycle is completed. Set points and reset points can be programmed, so that first pump on is the first pump off.

Pump Alternation Typical Application

Pump alternation setup

1. All relays are set up to respond to process/rate.
2. Relays 1 and 2 are set up to alternate.
3. Relays 3 and 4 are programmed for low and high alarm indication, respectively.

Set and reset point programming

Set point 1	30.00	Reset point 1	10.00	Controls pump #1
Set point 2	35.00	Reset point 2	5.00	Controls pump #2
Set point 3	4.00	Reset point 3	9.00	Controls low alarm
Set point 4	40.00	Reset point 4	29.00	Controls high alarm

Pump alternation operation

1. Pump #1 turns on when level reaches 30.00, when level drops below 10.00 pump #1 turns off.
2. The next time level reaches 30.00, pump #2 turns on, when level drops below 10.00 pump #2 turns off.
3. If the level doesn't reach 35.00 pump #1 and pump #2 will be operating alternately.
4. If pump #1 can't keep the level below 35.00 pump #2 will turn on at 35.00, then as the level drops to 10.00 pump #1 turns off, pump #2 is still running and shuts off below 5.00.
5. With set and reset points of pump #2 outside the range of pump #1, first pump on is the first pump to go off. This is true for both pumps.

Switching Inductive Loads

The relay contacts on the Options Board are already protected with suppression components (snubbers).

If additional suppression is required, this suppression can be obtained with RC networks assembled by the user or purchased as a complete assembly. Refer to the following circuits for RC network assembly and installation:

AC and DC Loads

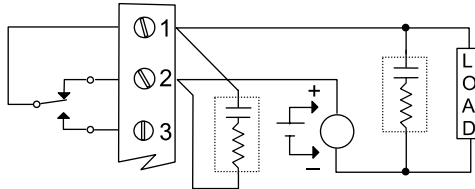

Figure 27. AC and DC Loads Protection

Choose R and C as follows

R: 0.5 to 1 Ω for each volt across the contacts

C: 0.5 to 1 μF for each amp through closed contacts

Notes:

1. Use capacitors rated for 240 VAC.
2. Snubbers may affect load release time of solenoid loads, check to confirm proper operation.
3. Install the RC network at the meter's relay screw terminals. An RC network may also be installed across the load. Experiment for best results.

Low Voltage DC Loads

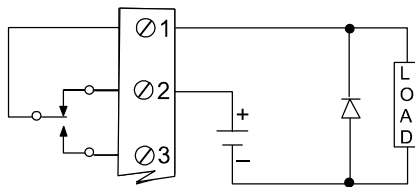

Figure 28. Low Voltage DC Loads Protection

Use a diode with a reverse breakdown voltage two to three times the circuit voltage and forward current at least as large as the load current.

4-20 mA Output Operation

Overview

The meter can be equipped with an isolated 4-20 mA output option that can be programmed to produce a 4-20 mA signal for virtually any process/rate display with at least a 501-count span.

Lockout and Display Selection Operation

Overview

The meter provides the user with the ability to restrict modification of programming values and to exclude menu titles from appearing during the menu scroll. Restricting modification of the programming values is accomplished by installing the lockout jumper (JP1). Excluding menu titles from the menu scroll is performed with the display menu.

Note: Selections made through the display menu (dSPLAY) can be made with or without the lockout jumper installed, but only become active when the lockout jumper is installed.

Low Voltage Detector

The meter has a circuit, which monitors the line voltage. To protect against data loss the meter will shut down, after saving the total, when the voltage falls below specifications.

At power up the display normally flashes a test display of **188888** for a few seconds. If the line voltage is below specifications the meter will flash **18888L** until the problem is corrected.

INSTALLATION

The meter overall dimensions are as shown:

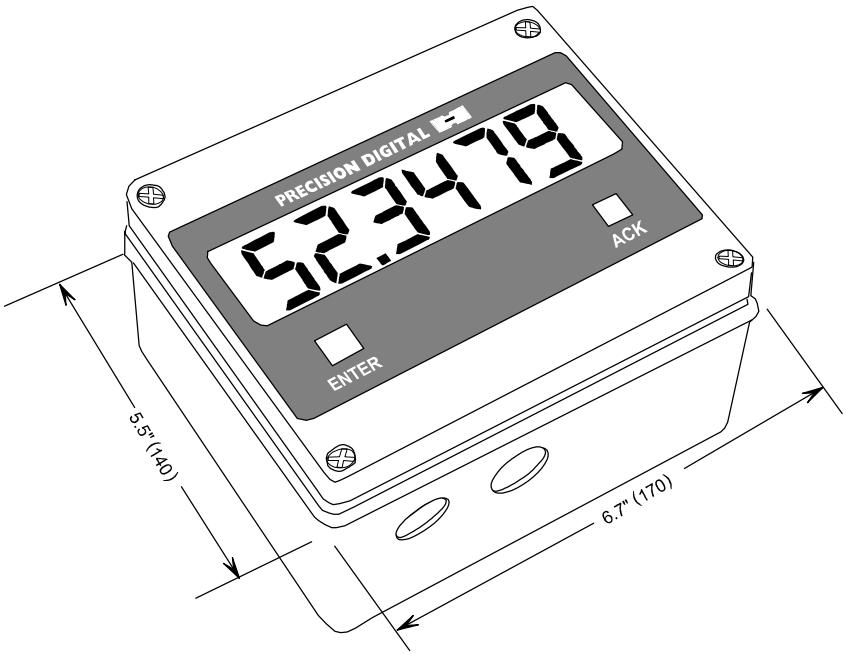

Figure 29. Overall Dimensions

Notes:

1. Overall dimensions: 6.7" x 5.5" x 3.7" (170 mm x 140 mm x 95 mm)
2. The bottom of the box is tapered down on all sides by 0.05" (1.27 mm).
3. The overall depth of the box (including the cover) is 3.7" (95 mm).
4. Approximate weight: 3.8 lbs (1.73 kg)

Wall Mounting Dimensions

There are four mounting holes on the rear of the enclosure. They are used to mount the instrument to a wall. The dimensions for the mounting holes are shown in the following figure.

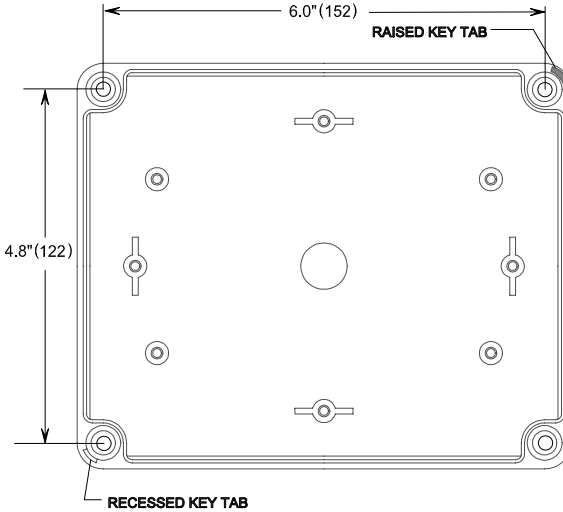

Figure 30. Wall Mounting Dimensions

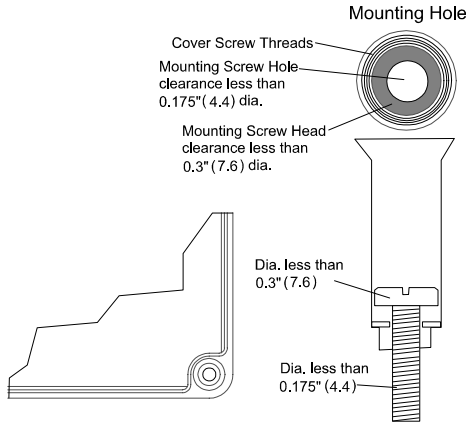

Figure 31. Wall Mounting Screw

Procedure:

1. Drill holes into the wall to accommodate suitable fasteners.
2. Remove the front bezel from the housing by removing the four mounting screws.
3. Align the enclosure mounting holes with the holes in the wall and insert the fasteners. Tighten the fasteners.

Panel Mounting Instructions

For applications where it is required to mount the meter into a panel, the PDA6554 panel mounting kit is available (see **Ordering Information** on page 8).

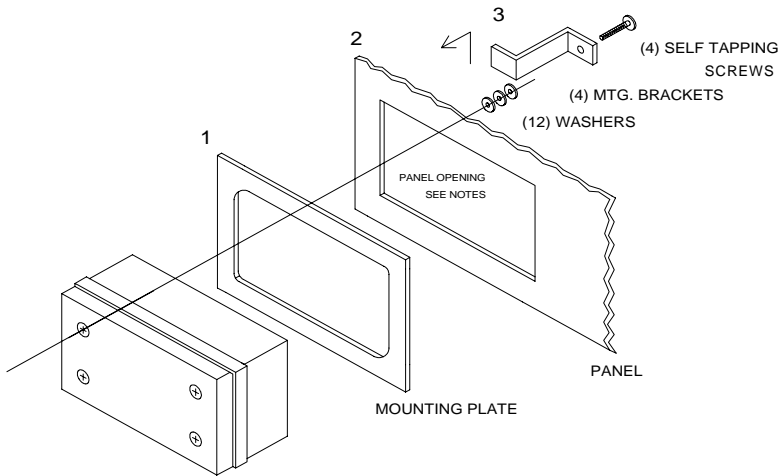

Figure 32. Panel Mounting Instructions

Instructions:

1. Insert the meter through the mounting plate.
2. Mount assembly on panel.
3. Secure with 4 brackets and 4 screws at corners of the meter. Use washers as needed to allow for panel thickness.

Notes:

1. Allowable panel thickness: 0.060" – 0.125" (1.5 mm – 3.2 mm)
2. Panel cutout required: 6.57" x 5.40" (167 mm x 137 mm)
3. Mounting plate overall dimensions: 7.57" x 6.40" x 0.125" (192 mm x 163 mm x 3 mm)
4. Mounting brackets require 0.8" (20 mm) on either top or side of meter for installation.
5. This panel mounting kit is not intended to provide waterproof protection to the panel.

OPTION CARD REMOVAL & INSTALLATION

Meter options are installed at the factory. To disable relays' fail-safe operation, it is necessary to remove the Display Board to gain access to the Options Board. Option cards may be ordered separately. Refer to the following instructions and illustrations.

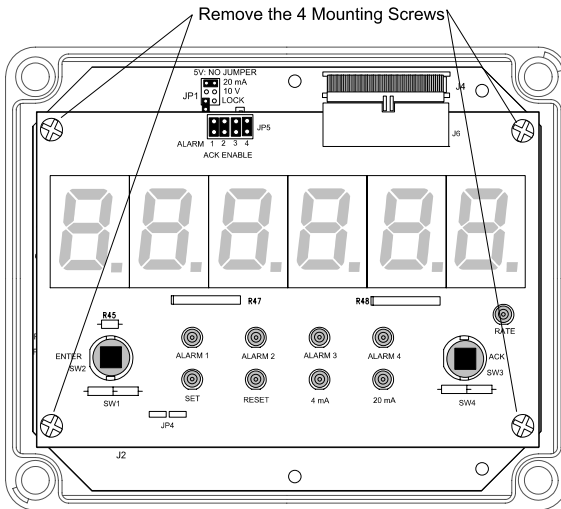

Figure 33. Removing the Display Board

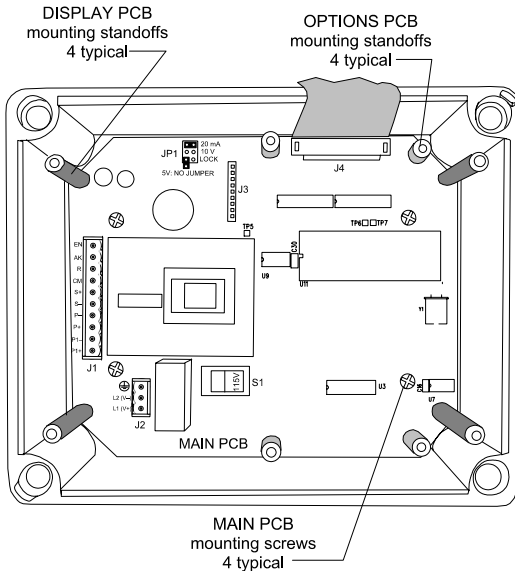

Figure 34. Options Board Standoffs Location

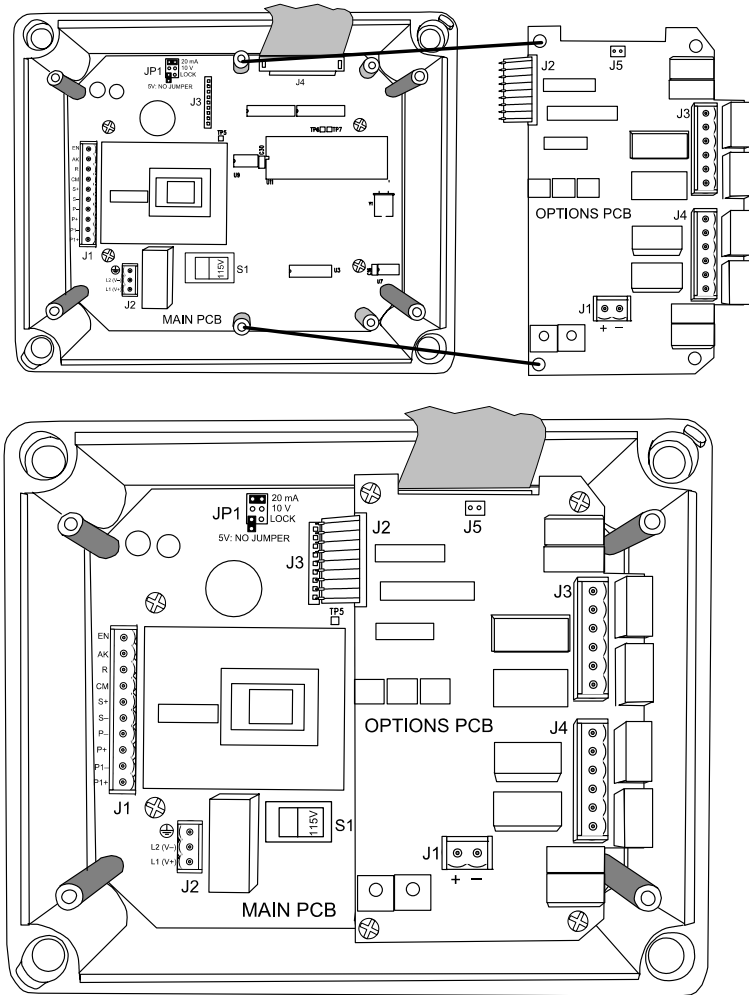

Figure 35. Installing Option Board

Instructions:

1. Disconnect power to the meter prior to removing the front cover.
2. Remove Display Board and detach Board from ribbon cable connector.
3. Remove Main Board from the base by removing four mounting screws.
4. Install Options Board standoff, using provided hex nuts.
5. Connect flexible cable connector J2 to J3 connector on Main Board.
6. Install four mounting screws to secure Options Board to standoffs.
7. Reassemble meter prior to applying power. Front cover may remain off until programming is completed to allow installation of lockout jumper. See Figure 15, page 29.

PROGRAMMED PARAMETER SETTINGS

The following table shows the factory setting for most of the programmable parameters on the meter. Next to the factory setting, the user may record the new setting for the particular application.

Model: _____ S/N: _____ Date: _____

Parameter	Display	Factory Setting	User Setting
Input range	SEL 20	4-20 mA	
Calibration mode	CAL 1b E-CAL	External calibration	
Type of signal	L InERr	Linear input	
Process/rate decimal point		299.99	
Number of points	2 Pt5	2 points	
Input 1	InPt 1	Apply 4 mA	
Display 1		0.00	
Input 2	InPt 2	Apply 20 mA	
Display 2		100.00	
Cutoff value	Cutoff	- 199.99	
Time base	SEC	Second	
Total conversion factor	tot CF	1.000	
Total decimal point	tot dP	999999	
Set point setup	SEt 1	Total	
	SEt 2	Total	
	SEt 3	Rate	
Latching relay	LATCH	Non-latching	
	SEt 4	Rate	
Latching relay	LATCH	Non-latching	

Parameter	Display	Factory Setting	User Setting
Total reset mode	E rSt	External total reset	
Set point values	SEt 1	1000	
	SEt 2	4000	
	SEt 3	70.00	
	(Reset 3)	60.00	
	SEt 4	90.00	
(Reset 4)	80.00		
4-20 mA output	(4 mA)	000.00	
	(20 mA)	100.00	
Display selection	dSPY r	YES	
	dSPY t	YES	
	rSEt t	YES	
	dSPY P	YES	
	SEtPtS	no	

User Multi-Point Scaling Table

Parameter	Display	User Setting
Input 1	<i>InPt 1</i>	
Display 1	<i>dSPY 1</i>	
Input 2	<i>InPt 2</i>	
Display 2	<i>dSPY 2</i>	
Input 3	<i>InPt 3</i>	
Display 3	<i>dSPY 3</i>	
Input 4	<i>InPt 4</i>	
Display 4	<i>dSPY 4</i>	
Input 5	<i>InPt 5</i>	
Display 5	<i>dSPY 5</i>	
Input 6	<i>InPt 6</i>	
Display 6	<i>dSPY 6</i>	
Input 7	<i>InPt 7</i>	
Display 7	<i>dSPY 7</i>	
Input 8	<i>InPt 8</i>	
Display 8	<i>dSPY 8</i>	
Input 9	<i>InPt 9</i>	
Display 9	<i>dSPY 9</i>	
Input 10	<i>InPt 10</i>	
Display 10	<i>dSPY 10</i>	
Input 11	<i>InPt 11</i>	
Display 11	<i>dSPY 11</i>	

User Set Point Setup and Programming Table

Parameter	Display	User Setting
Set point 1	SEt 1	
	LRECH	
Set point 2	SEt 2	
	LRECH	
	OFFSEt	
Set point 3	SEt 3	
	LRECH	
	OFFSEt	
Set point 4	SEt 4	
	LRECH	
	OFFSEt	
Total reset mode	1 or E	
Delay on release	dELAY	
Set point 1	SEt 1	
Reset point 1	(Reset 1)	
Set point 2	SEt 2	
Reset point 2	(Reset 2)	
Set point 3	SEt 3	
Reset point 3	(Reset 3)	
Set point 4	SEt 4	
Reset point 4	(Reset 4)	

Diagnostic Feature (*d 1A9*)

Overview

The Diagnostic menu in the meter provides an easy way to view and write down the parameter settings. The information gathered through the diagnostic menu will be helpful to determine if a wrong setting is causing the operation of the meter to be undesirable.

Operation

When the diagnostic menu is entered, the function and programmed parameter settings will be displayed one at a time. Press **ENTER** to step through the functions and settings. If **ENTER** is not pressed within 10 seconds, the display will move to the next function or setting. To exit the diagnostic menu press the **ACK** button at any time.

OTHER PRECISION DIGITAL PRODUCTS

Model	Description
PD118	MINIMUX [®] 8 Point Scanner
PD141AFO	VIGILANTE [®] four Point Annunciator with First-Out
PD202	General Purpose Digital Pressure Gauge
PD213-224	Industrial Digital Pressure Gauges (FM & CSA)
PD233-253	Precision Digital Test Pressure Gauges (FM & CSA)
PD602	Dart Low-Cost 1/8 DIN Process Meter
PD644	Javelin D High-Voltage DC Panel Meter (UL Listed)
PD650	2.3" LED NEMA 4 Large Display Process Meter
PD656	0.8" LED Exp-Proof Large Display Process Meter
PD660	Low-Cost NEMA 4X Loop Powered Meter
PD661	Low-Cost Exp-Proof Loop Powered Meter (FM & CSA)
PD673	4½ Digit Loop Powered 1/8 DIN Meter
PD675	4½ Digit Loop Powered NEMA 4X Meter (FM & CSA)
PD677	4½ Digit Loop Powered Exp-Proof Meter
PD685	3½ Digit Loop Powered NEMA 4X Meter (General Purpose)
PD686	3½ Digit Loop Powered NEMA 4X Meter (FM & CSA)
PD687	3½ Digit Loop Powered Exp-Proof Meter (FM & CSA)
PD690	1/8 DIN Analog Input Process Meter (UL Listed)
PD691	1/8 DIN Strain Gauge & mV Input Meter (UL Listed)
PD692	1/8 DIN Analog Input Flow Rate/Totalizer (UL Listed)
PD693	1/8 DIN Freq/Pulse Input Flow Totalizer (UL Listed)
PD696	1/8 DIN Loop Powered Flow Rate/Totalizer
PD697	NEMA 4X Loop Powered Flow Rate/Totalizer
PD698	Exp-Proof Loop Powered Flow Rate/Totalizer (FM & CSA)
PD740	Javelin T Low-Cost TC & RTD Temperature Meter (UL Listed)
PD750	TC & RTD Temperature Meter (UL Listed)
PD751	10 Ω Cu RTD Temperature Meters (UL Listed)
PD752	120 Ω Ni RTD Temperature Meters (UL Listed)
PD755	1.0" LED NEMA 4X Large Display Temperature Meter
PD756	0.8" LED Exp-Proof Large Display Temperature Meter

NOTES

How to Contact Precision Digital

- For Technical Support please
call: (800) 610-5239 or (508) 655-7300
fax: (508) 655-8990
e-mail: support@predig.com
- For Sales Support or to place an order please
call: (800) 343-1001 or (508) 655-7300
fax: (508) 655-8990
e-mail: sales@predig.com
- For Extended Warranty, Setup & Calibration Services please visit
www.predig.com
- For an online version of this instruction manual please visit
www.predig.com

